

# Stoelting

2004-2005

The Source for Physiology Instruments



Over  
**50**  
New  
Products



Stereotaxic Equipment  
page 1-12



Surgical Instruments  
page 30-49



Quixell™  
page 93



Micromanipulators  
page 100-110



Gas Anesthesia  
page 50-53



Histology Equipment  
page 61-68



Respirators  
page 54-55



Electrophysiology  
page 13-17

See back cover for  
additional products  
and accessories.



**Stoelting**  
SINCE 1886





# Digital Lab Standard™ Stereotaxic

*Saves Time and Improves Accuracy*

### YOUR CHOICE OF THREE OPTIONS

1. New Digital Lab Standard™ Stereotaxic Instrument complete with LED Digital Display.
2. Add new Digital Manipulator Arms and an LED Display to your current Lab Standard™ or similar brand of stereotaxic.
3. Convert your existing Lab Standard™ (or most other brands) by adding digital sensors to their manipulator arms. LED Display Module included.

Stoelting introduces its latest innovation to our line of premier Lab Standard™ Stereotaxic Instruments.

We have added a sealed electronic sensor, highly immune to outside interference and environmental conditions, to each axis of the manipulator arm. Measurements are accurate to 10 microns in all three directions, and movements are now monitored by a large, easy-to-read LED display module.

A zeroing function allows the user to set a reference point for targeting specific coordinates on the animal's skull for injection, implantation, etc. Calculation of distance measurements via the vernier scales is thus no longer necessary...saving the user valuable time and improving accuracy.

### Classic Lab Standard™ Design

The classic design and high quality of our conventional Lab Standard™ manipulators are exactly the same on the new Digital Stereotaxic, with no drift and smooth movements. The Digital Lab Standard™ keeps the custom triple-start lead screws to allow fast positioning, while maintaining consistently smooth movement. The thin cords from the sensors do not interfere with movements, allowing the arm to move freely and be set at any angle.

### Zeroing Function for Targeting Specific Coordinates

The display of each axis can be "ZERO"ed at any location, making operation simple and straightforward. To target a specific location, start at Bregma, and reset all coordinates to zero. Move the manipulator arm to the desired point and lower the electrode, probe, or micropipette into place.

### Memory

Target coordinates can be programmed into the memory of the 51900 and 51903 Digital Lab Standard™ Stereotaxics.

### Versatility of Positioning

The universal joint allows the investigator to angle the probe in either the anterior-posterior or the lateral-medial planes. The improved locking mechanism on the Lab Standard™ Stereotaxic Instruments will hold any angled position without slippage. Of course, it also provides an absolute lock at the vertical position. The manipulator arm may be swiveled out of the way for convenience in installing the animal or performing a procedure, then returned to the same point reliably with the aid of the locking face block above the swivel joint.



*Easy-to-read digital display offers precise measurements in all three axes.*

### Accessories

All of the accessories for the Lab Standard™ Small Animal Stereotaxic Instrument fit the 51900 and 51903 Digital Lab Standard™ Small Animal Stereotaxic Instrument. Probe holders and species adapters for "U" frame stereotaxic instruments made by other manufacturers are generally compatible with the Lab Standard frame.

### Included Components

The 51900 and 51903 Digital Lab Standard™ Small Animal Stereotaxic Instruments come complete with a standard probe holder with corner clamp (51631) and a

Rat Adaptor (51621) with nose holder and 18 degree taper ear bars. The 51950 and 51953 include the non-puncture (45°) ear bars instead of the 18-degree ear bars. They are otherwise identical to the 51900 and 51903.

The time-proven U-Frame design concept, rugged construction, and adaptability to most species used in the lab make Stoelting's Lab Standard™ series the best choice for stereotaxic instruments.

#### OPTION 1

##### Complete New System

- 51900** Digital Lab Standard with LED Digital Display, 18° EarBars
- 51950** Digital Lab Standard with LED Digital Display, 45° Ear Bars
- 51903** Digital Dual Manipulator Lab Standard with 2 LED Digital Displays, 18° Ear Bars
- 51953** Digital Dual Manipulator Lab Standard with 2 LED Digital Displays, 45° Ear Bars

#### OPTION 2

##### New Digital Manipulator Arms and LED Display

- 51904** Digital Manipulator Arm, Left Hand, and LED Display
- 51906** Digital Manipulator Arm, Right Hand, and LED Display

#### OPTION 3

##### Factory Conversion of Existing Manipulator Arm

- 51914** Factory Conversion of Existing Left Hand Manipulator Arm to Digital plus LED Display
- 51916** Factory Conversion of Existing Right Hand Manipulator Arm to Digital plus LED Display

## Video Surgery System

This simple, compact, and inexpensive video system is perfect for monitoring stereotaxic surgery, or for teaching stereotaxic procedures in a laboratory



setting. For use with a computer, the PCI card comes with basic software for screen captures (jpeg or bitmap) or for making video clips (.avi files). Also available is Image Management Software, a resource management program for maintaining a database of recorded images and files on the computer (for video imaging, image storage, and documentation of procedures or experiments).

- 50470** CCD camera
- 50471** 5.5" portable video screen
- 50472** Gooseneck camera holder
- 50473** PCI card
- 50474** Image Management Software

# Lab Standard™ Stereotaxic Instrument

## *Single and Dual Manipulator Models*

The Lab Standard™ Stereotaxic Instrument, manufactured by Stoelting, is ideal for researchers in need of a versatile, reliable instrument for stereotaxic procedures with small animals. Precision alignment when using the Lab Standard™ ensures accurate placement of electrodes, micropipettes, and other devices.

The time-proven "U"-Frame design concept, sturdy construction, and adaptability to most model species make this the best choice for a stereotaxic instrument.

**Stoelting's Lab Standard™ offers several advantages over competing instruments:**

### **Easily Read Scales**

All scales are oriented to be read easily from the open end of the "U". This is the position from which most scientists prefer to work. **The numerals on the scales are larger, and therefore more easily read.** The scale lines are laser engraved, to allow finest possible permanent marking of scales on all 3 axes. Precise alignment with facing vernier scales gives accurate resolution to 0.1 mm.

### **Smooth Movements**

The Lab Standard's™ **exclusive, triple lead screws** allow the fastest positioning possible, consistent with lining up the scales easily at a given coordinate.

### **Versatility of Positioning**

The manipulator arm controls medio-lateral and vertical positioning via lead screws, and antero-posterior movement via dovetail slide movement, with **80 mm of travel possible in each direction.** A Universal Joint allows the investigator to **change the angle of the probe up to 90°** in either the antero-posterior or medio-lateral planes. The improved locking mechanism on the Lab Standard™ will hold any angle position without slippage. And of course, it also provides an **absolute lock at 90° vertical.**

In addition, a swing joint allows the investigator to conveniently swing the manipulator arm and probe out of the way for performing a procedure – then reliably return the probe to the same point.



**51600 Single Manipulator Model**

See pages  
14-21 for  
Electrophysiology  
and Recording  
Equipment

## **FEATURES**

- Large, easy to read vernier scales
- Scales are laser engraved – accurate to 100 microns
- Triple lead screws for fast positioning
- 80 mm of vertical, lateral and anterior-posterior travel
- Absolute lock at 90° (vertical)
- Brass bushings in manipulator arm permit electrical grounding
- Useful with a variety of instruments
- Accessories available for use with a wide variety of small animals

## Convenient for Electrophysiology

Integral brass bushings in the manipulator arm allow grounding directly to the closest metal on the manipulator arm—even the probe holder.

## Dual Manipulator Model

The 51603 Dual Manipulator Lab Standard™ has 3-dimensional manipulator arms on both sides, the second manipulator arm being properly reversed as to handedness. Dual manipulators are very useful in studies in which double injections or simultaneous stimulation and recording are necessary.



51603 Dual Manipulator

## Included Components

Both the 51600 and 51603 include the U-frame base plate, manipulator arm(s), standard probe holder(s) with corner clamp, and Rat Adaptor (nose clamp assembly and 18° taper ear bars). The 51650 and 51653 include non-puncture 45° ear bars instead of 18° ear bars.

## Selection of Accessories

Species adaptors are available to fit rat, cat/monkey, dog/monkey, mouse, guinea pig and small bird. Probe holders and species adaptors for "U" frame stereotaxic instruments from other manufacturers are generally compatible with the Lab Standard™ frame.

<b>51600</b>	Lab Standard™
<b>51650</b>	Lab Standard w/ 45° Earbars
<b>51603</b>	Dual Manipulator Lab Standard
<b>51653</b>	Dual Manipulator Lab Standard w/45°
<b>51601</b>	U-Frame, Base Plate and Rat Adaptor only, w/o Manipulator Arm

## Exclusive Accessories Fit all Lab Standard and most other Stereotaxic Instruments



**NEW** Cunningham Mouse & Neonatal Rat Adaptor  
No. 51625 (See page 5)  
Fits all Lab Standard and most other Stereotaxic Instruments.



Gas Anesthesia Platform  
No. 50264 (See Page 5)  
Use on No. 51625 Mouse & Neonatal Rat Adaptor or as a stand-alone anesthesia platform for general surgery.



Stereotaxic Injector  
No. 53310 (See Page 11)  
Capable of injecting sub-microliter volumes directly into the brain.

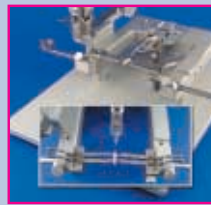

Spinal Surgery Adaptor  
No. 51690 (See Page 9)  
Firmly positions spinal cord of rats and mice for easy implanting, injecting and hemisectioning.

See page 21  
for new  
Midgard  
Precision  
Current  
Source for  
Iontophoresis

## Gas Anesthesia Mask

### For Mice or Rats in a Stereotaxic Instrument

The Anesthesia Masks for Stereotaxic instruments, enables gas anesthesia of rats or mice in a Lab Standard™ or other stereotaxic instrument, without exposing the researcher to the anesthetic.

The Gas Anesthesia mask is installed over the incisor bar, with the cone opening toward the open "U". The animal (rat or mouse) is installed by placing its teeth over the incisor bar, and sliding the adaptor forward until the cone is snug about the animal's nose, thereby substituting for the nose clamp. The teeth and the cone provide a snug, stable hold.

Anesthetic gas flows in the tubing connector, past the animal's nose, and out the other side. From there, spent gas may be routed to recycling, exhaust, or gas analysis



**51609**  
Mouse Mask



**51610**  
Rat Mask on Rat Adaptor (Not Included)

instruments. The new design of the Mouse Gas Anesthesia Mask dramatically increases the efficiency of anesthetizing.

<b>51610</b>	Gas Anesthesia Mask, Rats
<b>51609</b>	Gas Anesthesia Mask, Mice





51800 stereotaxic instrument shown on 51871 base plate (not included)

51858 A/P Microdrive

## FEATURES

- Reliable Locks
- Laser Engraved Scales
- Exceptionally Accurate
- Affordably Priced

The Lab Standard™ Large Animal Stereotaxic Instrument, manufactured by Stoelting, provides superior performance. **Up to four manipulator arms may be conveniently positioned on the two parallel rails. Thus, several probes may be independently positioned in one animal.**

### Easily Read Scales

Precise, laser engraved graduations allow vernier scales to be aligned to 0.1 mm. The scales are oriented to enhance readability from common user positions.

### Reliable Locks

If it is necessary to tilt the stereotaxic frame to gain access to the animal's side or underside, the tilting and angling universal joint on Lab Standard™ manipulators have the most secure, reliable locks of any stereotaxic instrument.

# Large Animal Stereotaxic Instrument

## Components Included

The 51800 comes equipped with:

- Two 51804 LH Manipulators
- Two 51806 RH Manipulators
- One 51801 Parallel Rail Frame including one 51826 Cat/Monkey Head Holder w/18° ear bars and 51680 Universal swivel stand with 4" x 4" mounting support plate

Base plates are ordered separately.

The 51851 Dog Frame is longer, includes a highly adjustable dog head holder (51852) and 2 sets of earbar blocks to allow configuration for large dogs.

## Versatile

Other species adaptors and ear bars manufactured by Stoelting may be used on the 51800 series of stereotaxic instruments.

The optional 51858 Anterior/Posterior Microdrive provides fine movement control in the A/P dimension with 25 mm range and 10 μ graduations. The 51858 mounts between the rail and the manipulator and it includes a longer probe holder shaft for the extra height.

## Optional Base Plates

A 4" x 4" mounting plate with 2 sets of four mounting holes is included with the 51800 series stereotaxics. The optional 51872 base plate has four, full-length tee slots for mounting other instruments on the same base with a 51800 stereotaxic. The optional 51871 is a 13" x 17" flat base plate without slots.

<b>51800</b>	Stereotaxic, Cat/Monkey, Complete
<b>51801</b>	Parallel Rail Frame Assembly Only
<b>51850</b>	Stereotaxic, Dog, Complete
<b>51851</b>	Stereotaxic Frame Assembly Only, Dog
<b>51852</b>	Dog/Monkey Adaptor
<b>51871</b>	Base Plate, 13" x 17"
<b>51872</b>	Base Plate, Slotted, 12" x 36"
<b>51804</b>	Manipulator, LH
<b>51806</b>	Manipulator, RH
<b>51858</b>	Microdrive, A/P

See pages 22 & 23 for reference books, brain maps, and atlases for stereotaxic surgery.



**Stoelting**  
SINCE 1886

620 Wheat Lane, Wood Dale, Illinois 60191 USA

Phone: (630) 860-9700

FAX: (630) 860-9775

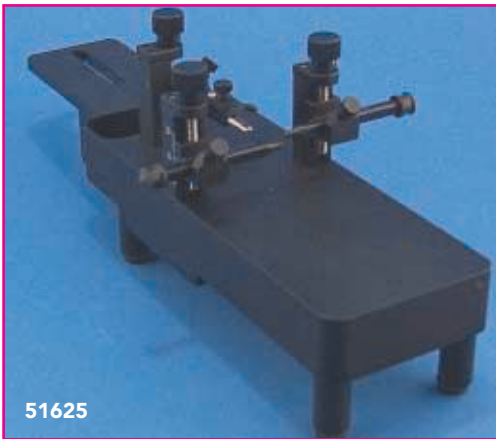

51625

## Cunningham™ Mouse and Neonatal Rat Adaptor

For 51600, 51800, and 51900 Series Lab Standard™ and most other Stereotaxic Instruments

The Cunningham™ Mouse and Neonatal Rat Adaptor, manufactured by Stoelting, employs light, Delrin® ear bars with tapered points on one end, and rubber pads on the other, to facilitate surgery on mice and rat pups.

Model organisms with soft skulls, such as the mouse and the neonatal rat, are difficult to secure firmly in a traditional stereotaxic instrument. The stainless steel ear bars used for adult rats are too heavy to provide a secure hold without compressing the sides of the skull inward

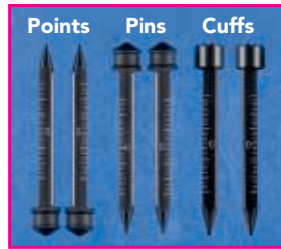

(which closes the airways and impedes blood flow.) Further, the neonatal rat pup has no external opening of the auditory canal into which to insert the ear bar points.

Ear bars may be independently adjusted in height, a unique feature of this stereotaxic instrument, to level the skull. Laser engraved scales show the vertical positions of the ear bars. A tooth bar and nose clamp secures the nose. A well, carved in the thick aluminum body, may be filled with dry ice and alcohol for hypothermic anesthesia of neonatal animals. The 51625 Adaptor clamps securely at the top of the "U" frame of the Lab Standard™.

New improvements to this popular stereotaxic instrument include an increased overall length to accommodate larger, more mature animals, and the addition of specialized jaw holder cuffs (51647), which securely clamp the zygomatic processes of the skull. The jaw holder cuffs fit over the ends of the ear bars, replacing the rubber pads, providing an alternative non-invasive means of securing the animal's head in the stereotaxic stage. These options for "triple point" securing of the animal's head in this adaptor make it the most versatile mouse stereotaxic available. **Set of two jaw holder cuffs included.**

**New! Extra-Small Homeothermic Blanket (fits 51625) available as part of our Homeothermic Blanket System. See page 27.**

- 51625** Mouse/Neonatal Rat Adaptor for 51600
- 51825** Mouse/Neonatal Rat Adaptor for 51800
- 51647** Jaw Holder Cuffs, set of 2

## Gas Anesthesia Platform

Precise and Secure Positioning During Surgery

The Gas Anesthesia Platform for Mice (No. 50264) allows for precise and secure positioning of an animal during anesthesia and surgery when used with Stoelting's Mouse and Neonatal Rat Adaptor (No. 51625). **It may also be used as a stand-alone platform for dorsal surgery.**

After removing the animal from the induction chamber, it can be quickly mounted on the platform. The animal's teeth are placed over the incisor bar and the mouse mask slid forward until the cone is snug about the animal's nose, thereby substituting for the nose clamp. **The platform is then lifted onto the Cunningham™ Mouse Adaptor, providing positioning of the animal that is perfect, automatic and effortless!**

### New Mouse Gas Mask Design

Our new improved mouse gas mask, with the gas inlet and outlet projecting back at a 45-degree angle, allows for easy connection to gas anesthesia and scavenger systems.

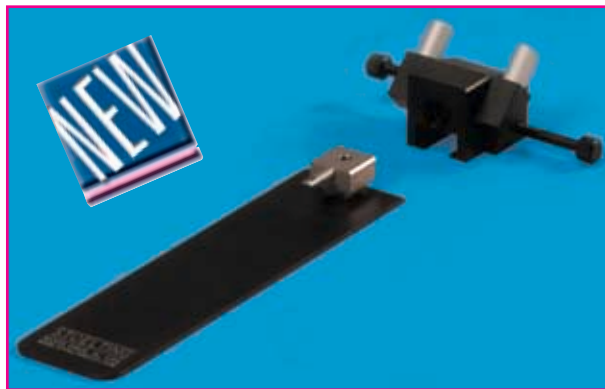

- 50264** Gas Anesthesia Platform plus Mouse Mask
- 50266** Gas Anesthesia Platform only
- 51609** Gas Anesthesia Mask, Mouse
- 50267** Gas Anesthesia Platform plus Rat Mask

**Save up to 70% on Surgical Instruments**  
See page 30

## LAB STANDARD™ probe holders

For 51600, 51800, and 51900 Lab Standard™ and Other Brands of Stereotaxic Instruments



51631      51632      51634

### Standard Probe Holders

Has 11 mm square acrylic block on the bottom with grooves spaced 1 mm apart. Grooves on three sides to facilitate loading of probes. The **corner clamp** holds shafts from 0.2 to 2.0 mm. The **side clamp** holds probes from 0.2 to 4.5 mm, as does "C" clamp, which is useful to release implanted probes.

The 51631 is included with each Lab Standard™.

- 51631** Holder w/corner clamp
- 51632** Holder w/side clamp
- 51634** Holder w/"C" clamp



51633

### Large Probe Holder

For shafts with diameters from 6.5 mm up to 13 mm (0.5 inch). This will hold Hamilton™ Micro-syringes or Stereotaxic Drills.

- 51633** Large Probe Holder



51637

### Microdialysis Probe Holder

Customized at Stoelting to fit a specific size of probe. The hole may be drilled to fit probes from 1.5 to 6.0 mm. **Default size is 1.5 mm.**

- 51637** Microdialysis Probe Holder



51638

### Double Head Large Probe Holder

This new Probe Holder has a large "C" gripping component at each end, with the "V" clamp attachment. Dual heads allow a secure hold for two different components. Clamps 1/4" - 1/2" diameter.

- 51638** Large Probe Holder



51636

Closeup

### Cannula Holder

Holds 3.4 mm cannula heads, as manufactured by Plastics One™, for cannula sets, and DURECT for ALZET® Osmotic Pumps. Non-intrusive for cementing cannulas in place.

- 51636** Cannula Holder, 3.4 mm

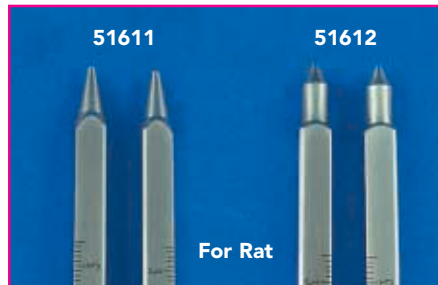

51611

51612

For Rat

### Lab Standard™ Ear Bars

Lab Standard™ Ear Bars have laser engraved scales and are 6.2 mm square. Ear bars for the 51600 and 51900 series of stereotaxic instruments have a different zero point than do those for the 51800 series. 18° Earbars taper at the tip to penetrate far into the ear canal for a more secure hold. Non-puncture ear bars have a 45° taper, and do not puncture the tympanic membrane.

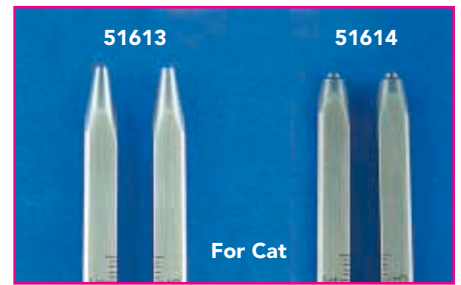

51613

51614

For Cat

### 51600 Series Ear Bars

- 51611** Ear Bars, Rat, 18°
- 51612** Ear Bars, Rat, 45°
- 51613** Ear Bars, Cat, 18°
- 51614** Ear Bars, Cat, 45°

### 51800 Series Ear Bars

- 51811** Ear Bars, Rat, 18°
- 51812** Ear Bars, Rat, 45°
- 51813** Ear Bars, Cat, 18°
- 51814** Ear Bars, Cat, 45°



## SPECIES ADAPTORS FOR STEREOTAXIC INSTRUMENTS

For the 51600, 51800, and 51900 Lab Standard™ And Other Brands of Stereotaxic Instruments

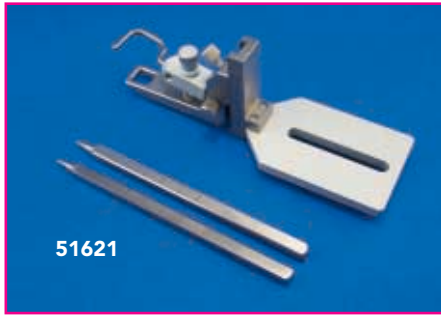

51621

### Rat Adaptor

The 51621 Rat Adaptor is included with the 51600, 51603, and 51900 Lab Standard™ Stereotaxic instruments. It has 30 mm of vertical travel along dovetail slide and 0.1 mm vernier scales. 50 mm of A-P travel possible. The nose clamp assembly and 18° ear bars are included.

- 51621** Rat Adaptor for 51600
- 51620** Rat Adaptor with 45° Ear Bars
- 51821** Rat Adaptor for 51800
- 51820** Rat Adaptor with 45° Ear Bars



51626

### Cat/Monkey Adaptor

The optional Cat/Monkey Adaptor for the 51600, and 51900 includes spacers and bolts (to raise the "U" frame 2.5 inches above the base plate), the eye socket/palate holder and 18° ear bars. The Cat/Monkey Adaptor is available with either standard or non-puncture 45° ear bars.

- For 51600**
- 51626** Cat/Monkey Adaptor
- 51627** Cat Adaptor, Non-puncture
- For 51800**
- 51826** Cat/Monkey Adaptor
- 51827** Cat Adaptor, Non-puncture



51852

### Dog/Monkey Adaptor

The Dog/Monkey Adaptor is available only for the 51800 series stereotaxic instruments. To fit any size dog, it should be used with 51850/51851 instruments, which have two sets of ear bar holders at different spacings from the front, to accommodate a wide size range of dogs. Includes one set of 18° ear bars.

- 51852** Dog/Monkey Adaptor

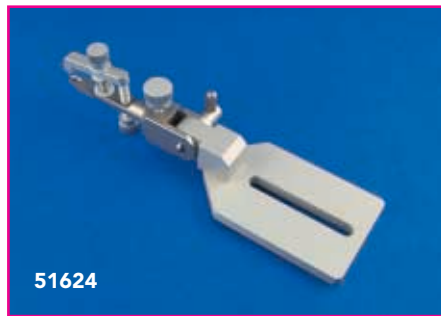

51624

### Mouse Adaptor

The 51624 Mouse Adaptor holds the mouse head by means of a palate bar and nose clamp, without ear bars. (Ear bars can cause breathing difficulties and bleeding in mice.) Head angle may be adjusted to achieve skull flat or other approach angles. Fits 51600, 51800, and 51900 series stereotaxic instruments.

- 51624** Mouse Adaptor

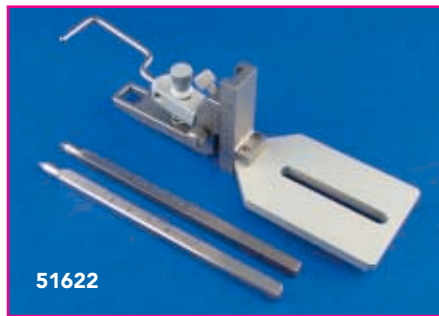

51622

### Guinea Pig Adaptor

The 51622/51822 Guinea Pig Adaptor includes the 45° ear bars required for guinea pigs. Also, the nose clamp reaches further back behind the incisors than on the rat adaptors. Capable of both vertical and A-P travel. It is available for the 51600, 51800, and 51900 series of stereotaxics.

- 51622** Guinea Pig Adaptor for 51600
- 51822** Guinea Pig Adaptor for 51800

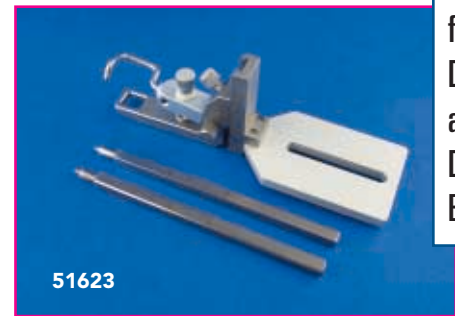

51623

### Small Bird Adaptor

The 51623/51823 Small Bird Adaptors include the 45° ear bars required for birds. The Small Bird Adaptor uses a beak support and "V" shaped beak clamp to hold the beak down and centered, in place of the incisor bar/nose clamp arrangement used for rats.

- 51623** Small Bird Adaptor for 51600
- 51823** Small Bird Adaptor for 51800

See pages 10-12 for Drills and Drill Bits

# Stellar™ Stereotaxic Instrument

*Easily Reach Any Point in  
the Brain From Any  
Angle...  
without calculations*

The Stellar™ Stereotaxic Instrument, manufactured by Stoelting, simplifies difficult stereotaxic surgery. Accurate interpretation of the results of stereotaxic surgery frequently depends on the use of multiple angles of approach to the target structure. If a deep structure is always approached over the same path, one can never rule out the possibility that electrode-induced damage to cortical tissue, or chemical seepage along the implant path, contributed to the observed post-surgical changes.

### Effortlessly Vary the Angle of Approach

The unique design of the Stellar™ allows variation in the angle of approach, without calculations, and without impairing the user's accuracy. This is accomplished via **rotation of the electrode carrier arm around the circumference of a sphere**. The animal is moved, rather than the electrode carrier, until the desired target area in the brain is at the center location. The electrode or injection pipette can then be advanced along any radius, the same distance, to the target location. The angle at

An optional Multiple Probe Carrier (50019) has "V" grooves to hold up to 10 probes, spaced at 1 mm intervals.



which the pipette/electrode is implanted can be adjusted through **45° in each direction along the medio-lateral and antero-posterior planes**.

### Easily Read, Laser Engraved Scales

Scales are located on one side of the instrument for convenient positioning of both animal and electrode carrier. The **numerals on the scales are large**, and therefore more easily read. The **scale lines are laser engraved**, to allow finest possible permanent marking of scales on angle adjustment. Precise alignment with facing vernier scales gives accurate **resolution to 0.1 mm** in vertical, antero-posterior, and medio-lateral directions.

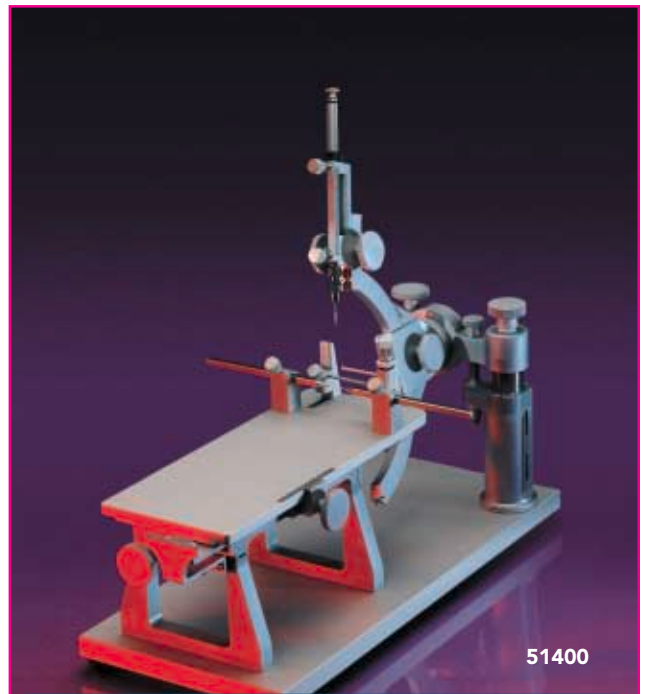

51400

- Reach midline structures without passing through the sagittal sinus
- Effortlessly vary the angle of approach
- Rotation of electrode carrier 45°, in medio-lateral and antero-posterior directions
- Precisely target any point, no math necessary
- Easily read, laser engraved scales
- Precision rack & pinion dovetail slides
- Zeroing holes for electrode alignment

### Smooth Movements

The Stellar™ is equipped with rack & pinion dovetail slides for effortless positioning of the animal, placement of electrode carrier, and quickly changing the angle of approach.

### Convenient Operation

A removable pin on the column of the electrode carrier arm allows the investigator to conveniently swing the electrode carrier arm out of the way during preparation, surgery, and drilling – with confidence that it will return to exactly the same point.

### Components

The Stellar™ Stereotaxic Instrument comes complete with a head holder (suitable for most rodents), ear plugs, 18° tapered ear bars and an electrode carrier with 4 collets (sizes 1/32", 1/16", 3/32", 1/8") for holding probes ranging from small wire to large glass pipettes.

51400	Stellar™ Stereotaxic
51412	45° Ear Bars
50019	Multiple Probe Carrier
50015	Ear Plugs

# Cunningham™ Spinal Surgery Adaptor

## To Hold Mice or Rats for Spinal Surgery

The design of this instrument was inspired by the need for a practical, versatile, and economical instrument for reliably stabilizing the spinal column. **The Cunningham™ Spinal Adaptor is an accessory to be mounted on the 51600 and 51900 series or other brands of stereotaxic instruments, converting them for spinal surgery applications.**

It utilizes the manipulator and base plate of the stereotaxic instrument, thus enabling precision spinal preparations. The spinal column is secured by up to four independent transverse process clamps, as well as a spinous process clamp. The transverse process clamps are designed to minimize trauma while providing motionless support.

The instrument is engineered for one-handed control of gross and fine adjustment of the surgical preparation in the AP, ML, and DV planes.

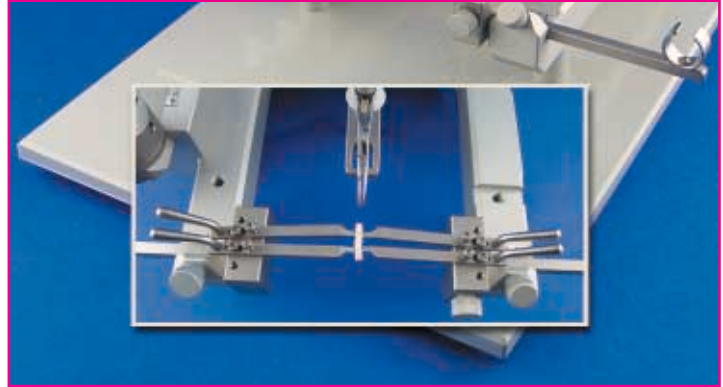

Transverse process clamps are available to accommodate either the rat or the mouse. **To work with both species, order one Spinal Adaptor and one set of transverse clamps for the other species.**

- 51690** Mouse Spinal Adaptor
- 51695** Rat Spinal Adaptor
- 51691** Mouse Transverse Clamps, Set/4
- 51692** Rat Transverse Clamps, Set/4

Save up to  
70% on  
Surgical  
Instruments.  
See page 30



# Hypophysectomy Instrument

**For Rapid, Efficient Positioning of a Hypodermic Needle in the Pituitary Gland**

See page 51 for a new low-cost Gas Anesthesia System

The 51202 Hypophysectomy Instrument, manufactured by Stoelting, is designed to accurately position a hypodermic needle in the pituitary gland, through calibrated, pivoting hollow ear bars.

The instrument can then be used to remove the pituitary or to inject substances into the pituitary gland. The off-center tooth bar assembly permits any of these operations to be done with the animal under gas anesthesia.

## Method of Operation

The animal is positioned and the suction needle is put in place for withdrawal of the pituitary gland. The pituitary of various sized animals can be easily located by adjusting the angle of the ear bars, length of needle and height of incisor bars. These steps are comparatively simple and little difficulty is encountered after the procedure has been performed several times.

## Included Components

The Hypophysectomy Instrument is supplied complete with instruction manual, 18 gauge hollow ear bar set and 18 gauge thinwall needle.

- 51202** Hypophysectomy Instrument



# STEREOTAXIC ACCESSORIES



DRILL MOUNTED ON STEREOTAXIC

58652

Drill Bits  
Many sizes available  
See Page 12

## Stereotaxic Drills

May be Mounted on Lab Standard™ or other Stereotaxic Instruments

This drill with a flexible drive shaft is configured by Stoelting for stereotaxic surgery. The powerful motor and flexible shaft offer very low vibration and noise for long-term, reliable performance.

The motor may be suspended from the ceiling or from the optional 58652 Motor Support w/Table Clamp. The heavy metal foot pedal allows exact speed control, and does not slide away from your foot. An optional, hand-dialed speed control is available, for use with or without a foot switch.

The slim, ultrathin handpiece (1/2" diameter) has a collar that may be easily removed for mounting directly on the 51633 Large Probe Holder accessory for Lab Standard™ Stereotaxic Instruments.

The 58650 Drill includes motor, foot pedal, 1/2" handpiece with 3/32" collet, standard for dental drill bits, and a wrench for changing the collet.



58657 Ultrathin Handpiece

Optional 58654 Collet kit includes 1/32", 1/16", 3/32" and 1/8" (used for grinding bits from many manufacturers) collets. Optional 58656 handpiece and stand includes a heavy-duty handpiece with Jacobs® Chuck for bits up to 5/32", and a table clamp holder for hands-free operation. The heavy-duty handpiece fits the end of the flexible shaft, and is easily interchanged.

Catalog number 58655V is 220 Volt and CE approved.

### Specifications

Power: ..... 1/10 Horsepower  
Maximum Speed: ..... 18,000 RPM  
Shaft Length: ..... 39"  
Shaft Diameter: ..... 0.150"

- 58650** Flexible Shaft Drill
- 58655V** Flexible Shaft Drill, 220V, w/CE
- 58651** Speed Control Dial, Optional
- 58653** Foot Speed Control, Replacement
- 58652** Motor Support w/Table Clamp
- 58654** Optional Collet Kit
- 58656** Jacobs® Chuck Handpiece and Stand
- 58657** Optional Ultrathin Handpiece
- 51455-5** 1.35mm Drill Bit (pk 6)
- 51457** Bone Anchor Screws (pk 100)



Drill kit includes handpiece, controller and foot pedal

## Micromotor® Drill

For High Speed Drilling With Easy Positioning

Micromotor® technology allows the handpiece itself to contain the motor, yet still maintain a slender profile for easy hand grip. The motor operates at 45,000 RPM with variable speed set by the controller box or the foot pedal control (both included). The motor operates quietly and vibration free.

The handpiece is coated with a soft grip material and contoured for a secure and comfortable hand grip. The quick-release rotary type chuck opens and closes collets. Two collets, 1/8" and 3/32" (standard dental drill bit size) are included.

- 51453** Micromotor® Handpiece Drill Kit



# Stereotaxic Injector, Stepper Motorized

## For Precisely Controlled Infusion of Nanoliter Volumes

The remote injection head is designed to be mounted on all Lab Standard™ and other brands of stereotaxic instrument, to precisely control the volume and the flow rate of injections. **Injection directly through a needle on the syringe avoids the inaccuracy introduced when injections are forced through a plastic tubing.**

The stepper motor pushes the plunger of a Hamilton® 700 (or 7000) series syringe (page 85), **from 10 µl to 100 µl. Flow rate and volume are set by the user. Volumes as small as 1 nanoliter may be set, and flow rates from 0.01 µl/min to 200 µl/min.** Slow infusions are more likely to stay in place, and not be forced back along the needle track, since the neural tissue has more time to adjust to the incoming fluid.

The syringe drive controller contains a library of common syringes and plunger diameters, so the user may simply scroll the list to select the syringe. The 53310 Stereotaxic Injector cannot be mounted on the Stellar™ Stereotaxic Instrument.

**See page 85 for a selection of compatible syringes**



53310 Mounted on 51600 Lab Standard

### Specifications

Resolution: .....6.3µm per 1/2 step  
 Syringes Accepted: .....Hamilton 700 & 7000 Series, 10 µl to 100 µl  
 Syringes Not Accepted:.....Hamilton Gas Tight Series  
 Minimum Flow Rate:.....0.01 µl/min  
 Maximum Flow Rate: .....200 µl/min  
 Minimum Volume Settable: .....0.001 µl

53310 Stereotaxic Injector  
 51681 "V" Clamp Adaptor for mounting to 51600/51800 Stereotaxics



## Cordless Micro Drill

The new Cordless Micro Drill from Stoelting is designed for research applications that require surgical burrs and trephines.

**Save up to 70% on Surgical Instruments. See page 30**

Made of lightweight aluminum alloy for balance and control, the Micro Drill is powered by a rechargeable 6-volt nickel cadmium battery, and can function for up to 8 hours under normal operating conditions. Average speed is 14,400 RPM.

### Included Components

The Micro Drill comes with a hard plastic case with die-cut foam for convenient storage, a recharger, and 5 carbide steel burrs with ball sizes of 0.6 mm, 0.8 mm, 1.0 mm, 1.2 mm, and 1.6 mm.

Carbide burr drill bits have a shaft diameter of 2.3 mm and are 4.4 cm in length. No special tools are necessary to change burrs. A set of 5 assorted burrs is available separately.

**The Cordless Micro Drill is available as a 110 volt model only. 220 volt model or converter is not available.**

58610 Cordless Micro Drill  
 58609 Carbide burr drill bits, set of 5, assorted

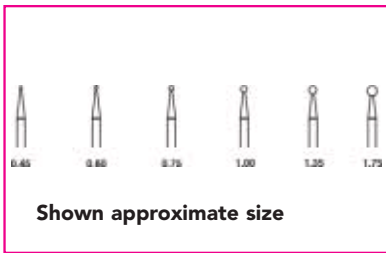

## Dental Drill Bits

High quality carbide drill bits cut cleaner and retain sharp edges longer. Suitable for use with the 58650 Stereotaxic drill, the 58600 Moto-Tool and the 51453 Micromotor drill. Spherical heads, variety of sizes. Packages of 6 bits (all the same size).

- 51455-1** Drill Bit .45mm, S, HP 1/4
- 51455-2** Drill Bit .60mm, S, HP 1/2
- 51455-3** Drill Bit .75mm, S, HP 1
- 51455-4** Drill Bit 1.00mm, S, HP 2
- 51455-5** Drill Bit 1.35mm, S, HP 4
- 51455-6** Drill Bit 1.75mm, S, HP 6



## Dremel Moto-Tool

A versatile hand-held useful throughout the lab. Use as a dental drill for skull openings, or to cut and grind stainless steel hypodermic tubing. Operates at variable speeds up to 30,000 RPM. Features permanently lubricated bronze bearings. An optional holder provides a sturdy base with a locking swivel for holding the Moto-Tool in any position, allowing use of both hands.

- 58600** Dremel Moto-Tool
- 58601** Moto-Tool Holder

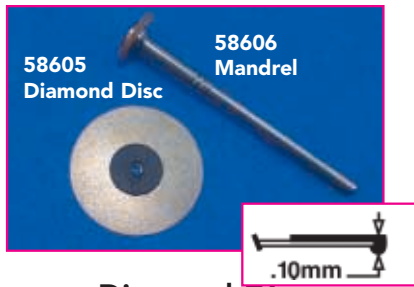

## Diamond Disc

A must for cutting or shaping stainless steel tubing for custom cannulas, knives or syringes. A diamond disc cuts, rather than grinds, its way through stainless steel tubing. The result is a fast, clean cut with little heat generation and no burrs to remove. Tubing is free of obstruction and ready to telescope together immediately after cutting.

- 58605** Diamond Thin Flex™ Cutting Disc, Unmounted
- 58606** Mandrel for 58605



## Micro Dissecting Needles

From Point Technologies  
Used for separating cells, these micro dissecting needles are made from pure tungsten, a metal with 3.5 X the hardness and 5 X the tensile strength of stainless steel. All tungsten micro dissecting needles have a sharp 1-micron tip.

Micro-needles are available in two lengths, 12 mm (0.5") or 25 mm (1.0"), and three different shaft diameters; 125, 250, or 500 microns. Supplied in a box of 10.

- 50704** .125 mm X 12 mm
- 50705** .250 mm X 12 mm
- 50706** .500 mm X 12 mm
- 50707** .125 mm X 25 mm
- 50708** .250 mm X 25 mm
- 50709** .500 mm X 25 mm
- 50700** Pin Vise, Pkg. of 3



## Dental Cement

Use to affix stainless steel to skull or bone, for lab repairs, or for casting of hard acrylic parts. Can be cut, drilled or ground. Sets up in minutes.

- 51458** Pink Opaque, 1 lb.
- 51459** Clear, 1 lb.
- 51456** Extra Solvent, 8 oz.

## Bone Anchor Screws

Anchor cannulae or other chronically attached appliances to skull. Stainless Steel Screws #0-80, 1.59 mm O.D., 3.2 mm long. Package of 100.

- 51457** Bone Anchor Screws, 100
- 51455-5** Drill Bit, 1.35mm, pkg. 6

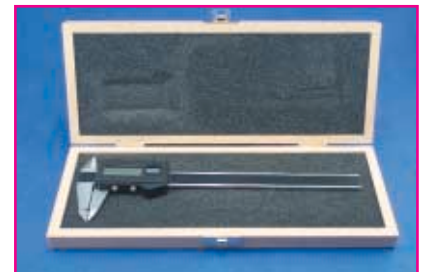

## Digital Calipers

Electronic digital calipers are a joy to work with. Readings in inches or metric at the touch of a button.

Resolution of .001" or .025 mm. Floating zero feature allows scale to read plus or minus a set point without calculations. Stainless steel. Lockable.

- 58750** Digital Calipers

## Electronic Timer

Use as a stopwatch, timer, for many lab purposes.

- 50286** Timer/Stopwatch



# Micro and Stimulating Electrodes

From Fredrick Haer Company

Needlecraft™ metal micro and stimulating electrodes are used by hundreds of research investigators worldwide. The configurations below are recommended for most acute and many awake animal experiments. A complete line of electrodes from FHC is available from Stoelting. Please call for assistance in selecting the best configuration for your research application.

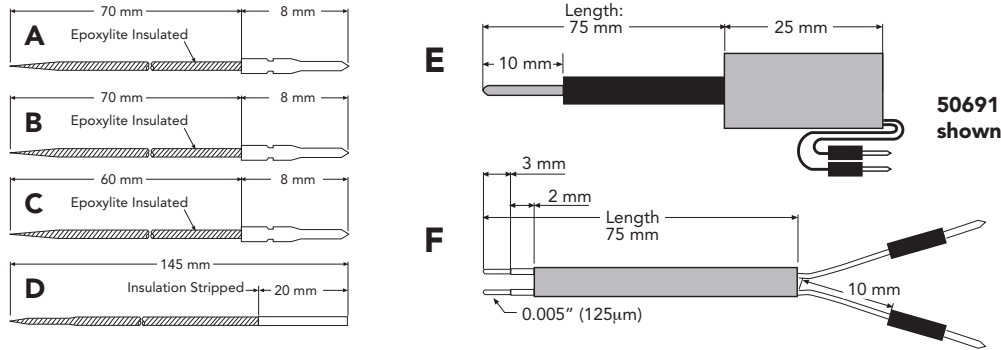

CAT. NO.	TIP TAPER	IMPEDANCE @1000 Hz	RECOMMENDED USE	
<b>Tungsten Microelectrode .008" Sold in Packages of 12 each</b>				
<b>A</b>	50675	Blunt	3 Meg	Recording from large or multiple cells near surface
	50676	Blunt	8 Meg	Recording from small cells near surface
	50677	Fine	3 Meg	Recording from larger cells in deeper structures
	50678	Fine	8 Meg	Recording from small cells in deeper structures
<b>Stainless Steel Microelectrode .010" Sold in Packages of 12 each</b>				
<b>B</b>	50679	Blunt	3 Meg	Recording from large or multiple cells near surface, iron marking
	50680	Blunt	8 Meg	Recording from small cells near surface, iron marking
	50681	Fine	3 Meg	Recording from larger cells in deeper structures, iron marking
	50682	Fine	8 Meg	Recording from small cells in deeper structures, iron marking
<b>Platinum/Iridium Microelectrode .010" Sold in Packages of 3 each</b>				
<b>C</b>	50683	Blunt	3 Meg	Recording from large or multiple cells near surface, micro stimulating
	50684	Blunt	8 Meg	Recording from small cells near surface, micro stimulating
	50685	Fine	3 Meg	Recording from larger cells in deeper structures, micro stimulating
	50686	Fine	8 Meg	Recording from small cells in deeper structures, micro stimulating
<b>Tungsten .010" Long thinned profile/ Max Dip Insulation Sold in Packages of 12 each</b>				
<b>D</b>	50687	Blunt	3 Meg	Recording from large or multiple cells near surface, awake animal recording
	50688	Blunt	8 Meg	Recording from small cells near surface, awake animal recording
	50689	Fine	3 Meg	Recording from larger cells in deeper structures, awake animal recording
	50690	Fine	8 Meg	Recording from small cells in deeper structures, awake animal recording
<b>Concentric Bipolar Electrode Sold in Packages of 3 each</b>				
<b>E</b>	50691	Outer Pole: 200µm SS; Inner Pole: 25µm PT/IR; Round Profile / For slice stimulation		
	50692	Outer Pole: 550µm SS; Inner Pole: 250µm SS; Pencil Point Profile / For <i>in vivo</i> stimulation		
<b>Parallel Bipolar Electrode Sold in Packages of 3 each</b>				
<b>F</b>	50693	Stainless Steel 1mm Spacing x 75mm long/ For <i>in vivo</i> or excised nerve stimulation		

Instant quotes including all shipping charges available online.

## Probe Centering Device

This accessory mounts on the "U" frame of the 51600, and allows replacing and centering the probe (only for use with ear bar 0 coordinates), without removing the animal. Hole is 30 mm above ear bar zero.

**51607** Probe Centering Device

## Centering Stand for Large Animal Stereotaxic

The Stand allows centering of probes to ear bar zero, before placing them on the 51801 or 51851 frames. It also serves as a storage fixture for 51800 series manipulator arms.

**51878** Centering Stand

## Stereomicroscope Kit

This kit enables a stereomicroscope to be positioned above the animal without contacting the manipulator arm. Spacer blocks move the manipulator two inches laterally for clearance.

**51608** Stereomicroscope Kit

Detailed illustrations online



## Basile Electroconvulsive Device

### New Biphasic Pulse Accessory and Ultra-Safe Corneal Electrode Applicator

The Basile Electroconvulsive Device is designed for inducing convulsions in research animals.

Consistent reproducible current levels are produced by feedback circuitry that adjust for variance in impedance of the contact from animal to animal.

The impedance to the animal can be pre-measured and displayed, and a warning signal flashes if the impedance is too great to deliver the desired current level.

The Electroconvulsive Device is supplied with auricular (ear lobe) electrodes. **Corneal electrodes (57803) are redesigned with a safety handle to protect while administering shock**, and an optional footpedal is available.



An optional Biphasic Unit box may be placed between the animal and the Electroconvulsive Device to invert every other pulse. Maximum frequency in this case becomes 100 Hz.

- 57800** Electroconvulsive Device
- 57802** Auricular Electrodes (included)
- 57803** Corneal Electrodes, optional
- 57805** Foot Pedal, optional
- 57808** Biphasic Unit, optional

For complete specifications of all of our products, visit [www.stoeltingco.com/physio](http://www.stoeltingco.com/physio)

**NEW!**  
Low-cost  
Treadmill  
See page  
74

## Lesion Making Device

### DC Constant Current

A precision instrument manufactured by Basile, the lesion making device provides constant DC current in mA from 00.01 to 99.99 mA. The pulse duration may be timed by the instrument between 1 and 99 seconds, or manually controlled.

A yellow LED warns when the impedance is too high for the preset current. The current generator is protected against accidental short circuit of the output.

### Specifications

Current Range .....	10 $\mu$ A to 99 mA
Max Electrode Resistance .....	20 M $\Omega$ (10 $\mu$ A) down to 2 K $\Omega$ (100mA)
Pulse Duration .....	1-99 sec. or manually controlled
Compliance Voltage .....	1-99V



**53500** Lesion Making Device



# XCELL 3+ Microelectrode Amplifier

The Xcell 3+ Microelectrode Amplifier is an extremely versatile low noise, high impedance signal amplifier for extracellular recording or stimulation applications.

## Noise Reduction

State-of-the-art integrated circuits act to lower noise while increasing bandwidth, making microelectrode recording more convenient. A probe preamplifier provides a high impedance, low noise, differential connection directly to the electrode carrier, minimizing external noise pickup.

The metal electrode carrier (included) conveniently plugs into the high impedance probe whose mounting rod is accepted by most stereotaxic instruments. The probe also accepts a glass microelectrode carrier.

## Signal Conditioning

A wide range of low and high cut-off filters allows the investigator to reject signals outside the bandwidth of interest. With a voltage gain adjustable from 10 to 100,000 in thirteen calibrated steps and a wide dynamic output range of +10V, the Xcell 3+ can be interfaced with any data acquisition or storage system, including PowerLab®.

## Impedance Testing

When activated, a 10nA, 1000Hz current is passed through the electrode at the positive input. The impedance of the electrode is displayed on a 3-digit readout.

## Audio Monitoring

A built-in speaker provides audio monitoring of signal activity. A noise filter eliminates baseline noise from the audio output.

## Stimulation/Lesion Making

A switch on the front panel electrically disconnects the microelectrode from the preamplifier input and connects it instead to a front panel connector (AUX). Stimulation or lesion currents can then be made through the electrode. The Xcell 3+ Microelectrode Amplifier comes complete with the high impedance probe, which connects to the module via a 2.5m cable, and the metal electrode carrier, which plugs into the probe. An optional glass microelectrode carrier is also available. May be conveniently rack mounted.



## Specifications

### Amplifier:

Input .....	Differential
Input Impedance .....	106 MOhm
Input Bias Current .....	<4pA
Common Mode Rejection .....	95dB at 60Hz
Gain .....	10x to 100,000x in 13 steps
Frequency Response .....	0.1Hz - 15Hz (-3dB)
Filter Cutoff Slopes .....	-12dB/octave
High Cutoff Ranges (Hz) (-3dB) .....	50, 100, 500, 1K, 2K, 5K, 15K
Low Cutoff Ranges (Hz) (-3dB) .....	0.1, 1, 10, 50, 100, 500, 1,000
Input Dynamic Range .....	+1V
Output Dynamic Range .....	+10V
Output Offset .....	Adjustable from -1.5 to +1.5 Volts
Cal Signal .....	100Hz square wave, equivalent to 100 mV at probe input
Line Filter .....	50/60Hz (specify) -40dB attenuation

### Impedance Check:

Impedance .....	3 digit red LED display
Measurement Ranges .....	KOhm (1-999); MOhm (0.1-9.99)
Measurement Current .....	10nA, peak-to-peak
Frequency .....	1000Hz

### Audio:

Noise filter .....	yes, via on/off switch
Sensitivity (gain before noise filter) .....	adjustable, turn dial
Volume (gain after noise filter) .....	adjustable, turn dial

Module Dimensions .....	18cm x 21cm x 23cm
Weight .....	6.5 lbs. (3kg)
Probe Dimensions .....	5cm x 2.9cm x 1.5cm

<b>50507</b>	Xcell-3+ Microelectrode Amplifier
<b>50508</b>	Replacement Metal Electrode Carrier
<b>50509</b>	Glass Microelectrode Carrier (optional)

See  
page 13  
for  
Electrodes

**NEW!**  
Low-cost  
Activity  
Monitor  
See  
page 75



## General Purpose Amplifier

### Economical Transducer and/or Biopotential Amplifier for Input to a Computer

This four channel differential amplifier is suitable for most general animal laboratory applications, including transducer input and non-isolated biopotential signals. Each channel has two output jacks, one unfiltered D.C. (amplified raw input signal) for transducers and one A.C. with a choice of 4 low pass filters for biopotentials. Gain, offset and meter calibration are adjusted with ten-turn dials.

### Digital Display

A digital LCD on the front panel displays the time-averaged input on any one channel. A four position selector switch sets and shows which channel is being monitored.

### Accepts PowerLab® Transducers

Any transducer or instrument configured for the Bridge Amplifier can be plugged directly into the General Purpose Amplifier. The General Purpose Amplifier may be connected directly to the PowerLab® inputs via a standard BNC cable. Rack mount brackets and 4 input connectors included.

Save valuable time with Stoelting's Online Quotation System



**Not For Use On Human Patients, Inputs Are Not Isolated**

### Specifications

Input Gain ..... to 4000x, ten turn pot  
 Resolution (Noise Level) .... >.0.1mV p-p at input terminal  
 Input Range ..... -5.3 to +5.3 mV  
 Low pass Filters .....  $\Omega$  50/3/0.5/0.1  
 Transducer Excitation Voltage ..... 5 V DC  
 Output Impedance ..... < 60 Ohms  
 Output Voltage Range .....  $\pm$  10.5 V  
 Baseline (DC Offset) .....  $\pm$  8 mV at input terminal  
 Input Impedance to Ground ..... > .500 Ohms  
 Differential Common Mode Rejection Ratio ..... 50 dB  
 Update Rate ..... 3.4 sec

**56450** General Purpose Amplifier, 4 Channel



## Microelectrode Impedance Tester

This instrument is used to measure electrode impedance. It operates at 1000Hz with a nominal current of 10nA. The Impedance Tester, designed by FHC, incorporates a unique tuned oscillator/filter circuit to minimize interference. Impedance value appears on an easy-to-read three digit LED display. A flip of the switch on the front panel toggles between the KOhm (1-999) and MOhm (1-9.9) impedance measurement ranges. The Impedance Tester is line powered, may be rack-mounted, and is supplied with appropriate cables and connectors.

### Specifications

Measurement Ranges ..... KOhm (1-999); MOhm (1-9.9)  
 Measurement Current ..... 10nA, peak-to-peak  
 Dimensions ..... 5 1/2" x 7" x 9"  
 Weight ..... 4.5 lbs

**50695** Impedance Tester

# Slope/Height Window Discriminator

## Amplitude and/or Time Window Discrimination

The Slope/Height Window Discriminator sorts extracellular spikes based on amplitude and waveform. In the amplitude mode, three adjustable voltage levels may be set to define two amplitude windows. In the time mode, a time window from 0.4 to 8 msec wide can be positioned between voltage levels 2 and 3 for resolution of signals which have similar amplitudes but different wave shapes.

## 5 Channels of Multiplexed Output

This unique instrument generates multiplexed output of five channels: the signal input, three voltage levels, and a monitor channel. The monitor channel may be switched to display either time window acceptance pulse or both amplitude window acceptance pulses. When output is displayed on an oscilloscope (not included), it is easy to discriminate between individual neurons firing. TTL outputs, each with an LED, indicate when each voltage level has been crossed and when the amplitude or time window criteria have been satisfied.

## FEATURES

- Front panel knobs for gain and polarity control
- Analog delay line permits examination of an entire waveform on a single oscilloscope sweep
- Multiplexer can be disabled so that output displays only the input signal
- May be conveniently rack mounted

Discriminate by waveshape: spikes 1 and 2 (shown here superimposed) can be resolved by waveshape if the position of the time window (triggered when the signal crosses LEVEL 1), is set so that spike 1 passes through

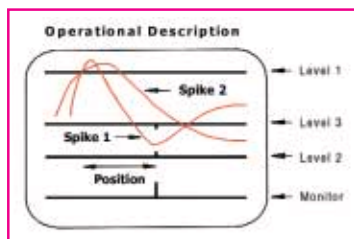

the time window (indicated by marks between LEVEL 2 and LEVEL 3), generating a time window pulse. Spike 2, of similar amplitude but different waveshape, misses the window.

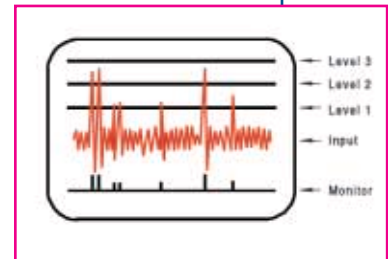

Or discriminate by amplitude: the discriminator can differentiate between those spikes which cross LEVEL 1 but not LEVEL 2, and those which cross LEVEL 2 but not LEVEL 3. On the Monitor channel, the amplitude of Window 2 pulse is twice that of Window 1.

## Specifications

Input Impedance .....	500 KOhm
Input dynamic range .....	10V peak-to-peak @ gain of 1
Frequency response .....	5Hz-20KHz
Voltage gain .....	0-10, continuously adjustable
Voltage levels (3) .....	Adjustable over -5V to +5V
Time window position .....	Adjustable, 0.4-8 msec
Multiplex frequency .....	200KHz
Multiplexed output .....	5 ch, on single oscilloscope display
TTL outputs .....	+5V, 0.15 msec, LED indicators
Delay variable .....	1-15 msec
Dimensions .....	5 1/2" x 7" x 9"
Weight .....	4.5 lbs.

Compatible with any **analog** oscilloscope (not included). Will not work with digital oscilloscope.

**50500** Slope/Height Window Discriminator w/ Delay

Just turn it on and begin recording!

**PowerLab®**  
Authorized Distributor

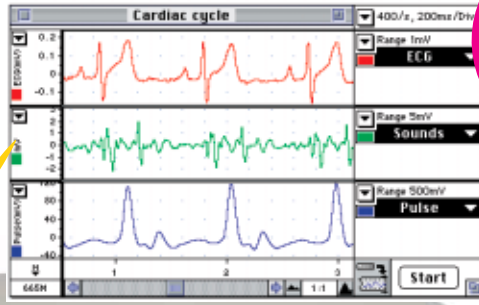

Call Stoelting for complete specifications and application information.

## PowerLab SP® Data Acquisition Systems

### FEATURES

- User Friendly – no programming required
- Fastest data collection
- Data scrolls on-line in real time

Simply plug PowerLab SP® in to your computer, load the software supplied with the system, and begin recording. There is no need to start a new file each time recording is stopped, then restarted. All experimental data is recorded in a continuous format, much like a chart recorder.

A configuration file can be saved (including gain and offset settings, chart speed and calibration settings) so that **two or more, very different, experiments can be configured for immediate start-up.**

PowerLab SP® can extract multiple types of data, **simultaneously**, from 1 transducer, so that you can view the entire collection of data, on one screen. For example, with only a blood pressure transducer, PowerLab SP® can extract, and display, heart rate, mean blood pressure, systolic pressure and diastolic pressure.

### Faster Data Collection

PowerLab SP® can collect data at up to **200,000 samples per second**, on one channel, continuously to a disk; or 40,000 samples per second on 4 channels, with a SCSI port. The PowerLab SP® is faster than almost any physiological data requirement. Efficient data compression routines minimize the disk space required. Or, for long-term monitoring, PowerLab SP® can collect samples at a rate as low as 1 sample per 5 minutes.

### Gain and Resolution

Twelve software-selectable gain settings, from 10 Volts down to 2mV, let the researcher take the maximum benefit from the 16-bit resolution. The full-scale range may be set as low as 2mV, (divided into 65,000). Features in the signal, too small to be seen on-screen, are still resolved. They can be stored in digits, by positioning the cursor over the point to be read. Signals, like those from a piezoelectric pulse sensor, are fully resolved without front-end signal conditioning or amplification.

Many transducers can be plugged directly into the front-end ports, without a front-end amplifier.

### Versatile Software

PowerLab SP® software includes 13 selectable filter settings per analog channel. In addition, several math conversion routines are built-in, including rate-meter integration, differentiation, mean, cyclic maximum and minimum, and others.

### Flexible Stimulator

Dual programmable stimulator outputs enable the researcher to generate pulse, dual pulse, train or stepped-amplitude waveforms. May be externally triggered via TTL.

### Digital Input/Output

Digital events and timing are important to many experiments. In addition to its trigger inputs, the PowerLab SP® instruments include a 9-pin Digital Input and a 9-pin Digital and USB outputs.

Chart® software (included) allows configuring a table of 8 possible comments. The table specifies the text of the comment; which of 8 available digital input pins, and/or which function keys will trigger that comment, and on which channel(s) the event should be marked. For example, a TTL pulse on digital input pin 3, may insert a marker line on channels 2 and 5, with a label, "animal pressed bar." Or, the experimenter may reserve certain function keys for fast entry of anticipated comments into a data stream. This allows the PowerLab® to function as an 8 event "Button Box" for entry of observational data or external events. Event data may be superimposed on selected on-going analog data collection channels.

**NEW!**

Low-cost  
Plethysmometer  
See page 77





Digital Output pins may be set to deliver a TTL pulse when a function key is pressed. Pre-scheduled times may trigger TTL outputs on one or more of 8 digital output pins. These may be used to trigger syringe pumps, stimulators or other equipment.

PowerLab SP® includes software and manuals for both Macintosh and Windows-based systems.

## Computer Requirements

Pentium processor with Windows 95/98/NT®; Windows98®/XP/2000. VGA, or better, graphics. Or, Macintosh® computer with MacOS®7 or later; MacOS® 8.5 for USB.

- 56504** PowerLab® 4SP, 4 channel
- 56508** PowerLab® 8SP, 8 channel
- 56516** PowerLab® 16SP, 16 channel
- 56402** SCSI Card for Windows® or Macintosh®, with cable (not included)

## AMPLIFIERS AND SIGNAL CONDITIONERS



### Single Bio-amp

A fully isolated differential amplifier with several filter settings, this is appropriate for any biological signal recording. An audio

out jack allows audible signals.

- 56325** Single Biological Amplifier
- 56322** Replacement Patient Cable
- 56323** Lead Wire, Pinch Adaptor, Set of 3
- 56324** Lead Wire, Snap Adaptor, Set of 3
- 56395** Quick Stick™ Disposable Sensors, box of 150

### Dual Bio-amp

Two biological amplifiers in one box share a common subject ground connection and a single cable input jack. Specifications are the same as the 56325 Single Biological Amplifier, except as shown below. Note the low frequency response range is extended down to 0.02 Hz.

- 56344** Dual Biological Amplifier
- 56346** Replacement Patient Cable, Dual

Comprehensive Specs available online at [www.stoeltingco.com/physio](http://www.stoeltingco.com/physio)



### Bridge Amps

Differential DC Bridge Amplifiers are used for transducers, or devices needing an excitation voltage. Simple signal conditioning onscreen with the Chart® software/PowerLab® interface.

- 56320** Single Bridge Amp
- 56321** Quad Bridge Amp
- 56340** Octal Bridge Amp



### Dual Bio-Amp w/stimulator

Similar to the Dual Bioamp, except has a constant current stimulator isolated from ground and from the bioamplifier common. Output limited in current, duration, and frequency to minimize risk to human subjects.

- 56345** Dual Bioamp w/Stimulator
- 56346** Replacement Patient Cable, Dual



### Blood Pressure Amp

The blood pressure amplifier is configured to record bp, and is fully isolated for patient safety. The blood pressure amp has built-in sub ranges and negative-inclusive (venous) ranges appropriate for blood pressure measurements. Comes precalibrated for use with the Disposable Blood Pressure Transducer sold below.

- 56361** BP Amp
- 56359** Disposable BP Transducer



### GSR/SCR Amp

Fully isolated amplifier with low voltage 75 Hz AC excitation and automatic zeroing. The low level AC excitation reduces electrode polarization artifact and drift found in DC systems. The GSR amp is galvanically isolated for human subject safety, and CE approved. Supplied with bipolar finger electrodes with Velcro™ strap.

- 56377** GSR Amplifier
- 56378** Replacement Finger Electrodes



## Bio Amp Leads and Patient Cables

Approved for human subjects, when used with PowerLab® Bio Amps.

- 56323** Lead, Pinch Adaptor, set of 3
- 56324** Lead, Snap Adaptor, set of 3
- 56322** Patient Cable
- 56346** Patient Cable, Dual



## Quick Stick™ Disposable Sensors

Pre-gelled, disposable, hypoallergenic electrodes used with Pinch or Snap Adaptors. Pack of 150.

- 56395** Quick Stick™ Electrodes



## Pressure Transducer

General Purpose Pressure Transducer can be used with any bridge amp. Measures blood pressure directly via catheter. For animal use only.

- 56360** Pressure Transducer
- 56363** Replacement Domes



## Blood Pressure Cuff

Connects to 56360 Pressure Transducer, for electronic monitoring. Use with Electronic Stethoscope.

- 56375** Pressure Cuff



## Recording Dynamometer

Smedley Dynamometer, with strain gauge transducer, records grip strength, fatigue and recovery rates. Connects to Bridge Amp, used with PowerLab®. Range 0-100 kg.

- 56380** Recording Dynamometer



## Piezo Pulse Transducer

Generates an electrical signal proportional to applied pressure/pulse. BNC connector, direct to PowerLab®. No pre-amp or excitation voltage needed.

- 56370** Piezo Pulse Transducer



## Respiration Transducer

BNC connector for input direct to PowerLab®. Fits 12" - 100" (using included velco belt).

- 56368** Respiration Transducer



## Electronic Stethoscope

Listen to patient heartbeat, while recording at the same time.

- 56372** Electronic Stethoscope

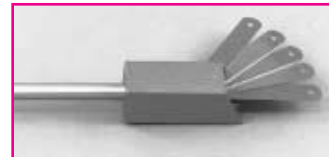

## Force Isometric Transducer

Five force ranges are provided by 5 leaf springs, 10 mg to 1 kg. Supplied with a connector for the bridge amplifier 56320.

- 56350** Force .01-1000g



## Isotonic Transducer, Hall Effect

Balanced like a phonograph arm, with minimal rotational inertia and friction, this Hall Effect transducer gives

excellent dynamic "following" of quick movements.

- 56356** Isotonic Transducer

# Midgard™ Precision Current Source

## For Iontophoresis

The latest generation of the popular precision current source, designed at M.I.T. for the iontophoresis of neural transport tracers such as horseradish peroxidase (HRP) or tritiated amino acids into neural tissue, is now available from Stoelting. It may also be used to make small lesions, and in applications requiring precise current control through high impedance.

### 3000 V Compliance Voltage

The Midgard features a high compliance voltage (3000 V) for injections from very small, or partially clogged, pipette tips. The output current level can be regulated to +/- 0.5%, from 0.0 to 200 MegOhms.

### Pulsed or Continuous Output

Pulsed output helps avoid clogging or polarization of the tip of the pipette. The user may select pulsed or continuous current with a switch. The pulsed on/off times can be varied from 0.5 to 24 seconds.

### External Control

Many users have requested external timing control for lab automation applications. The Midgard can be gated through a headphone jack on the rear panel by any laboratory logic pulse generator. The output current is

## Features

- Touch Screen Programmability
- Universal Power Supply
- Internal Memory
- Integral High Voltage Labels
- Real-Time Feedback of Current Status
- Error Warning For Current Interrupt
- Error Warning For Out-Of-Range

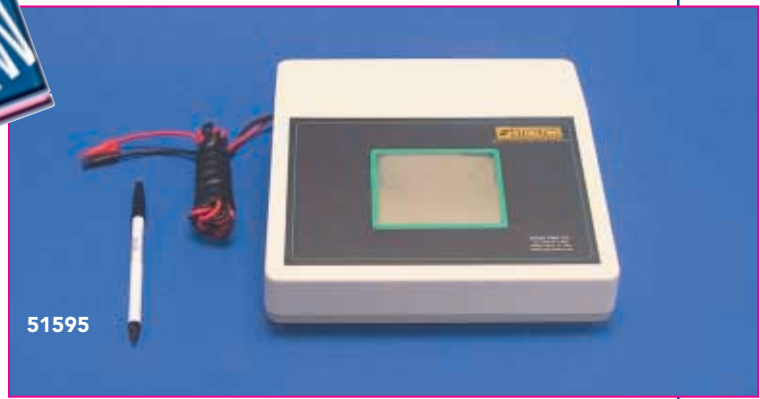

51595



Injections done with the Midgard

Tritiated prolineleucine. VM nucleus, thalamus. 1µA pulsed current, 10 minutes, 20 µ pipette

HRP in tris buffer, pH 8.6; rat; lateral habenula. 2µA pulsed current, 15 minutes, 12 µ pipette.



continuous whenever the gating jack is logic high, off when it is logic low.

A touchpad switch allows reversing polarity. This is useful when using a retaining current to hold the pipette contents in the pipette during entry into brain.

## Specifications

### OUTPUT

Output current:.....0.5 – 25 µA, set by touch pads  
 Compliance voltage: .....3000 V  
 Load current accuracy: .....0.5% at 0-200 MegOhms  
 Load current reproducibility:.....0.25%  
 Polarity: .....±, user selected  
 Display resolution:.....0.01 µA  
 Output connectors:.....Two integral H.V. Cables

### PULSED MODE OPERATION

Pulse duration:.....0.5 to 24 seconds, variable  
 Duty cycle: .....preset to 7 sec. on / 7 sec. off  
 Timing error: .....± 5%  
 Load current fall time: .....0.1 sec.  
 Load current rise time: .....Dependent on load resistance.  
 For 7.0 mA through 200 MegOhms, rise time to 99% of set value is 1 sec.; over-shoot less than 5%.

51595 Precision Current Source  
 50880 Silver Wire .13mm (.005")

**NEW!**  
 New Touch  
 Screen  
 Vertical  
 Pipette Puller  
 See page 97





The most widely cited atlas in neuroscience.

## The Rat Brain in Stereotaxic Coordinates

**Paxinos & Watson**  
4th Edition

Cresyl Violet and AChE stained sections. The horizontal reference plane used shows bregma & lambda at the same vertical level.

Includes 46 sections at 5 mm intervals from all 3 cardinal planes, plus 22 spinal cord cross-sections.

- 45003** Rat Brain Atlas, 4th Ed
- 45002** Rat Brain Atlas, + CD

## Brain Maps: Structure of the Rat Brain

**Larry W. Swanson**

240 pages include several diagrams illustrating the divisions and subdivisions of the rat brain. This stereotaxic atlas includes 73 Nissl stained sections with line drawings on facing pages, and a summary of rat brain development with 10 figures. This is an essential research or teaching tool. All drawings are included on CD, and can be modified in CorelDRAW or other graphics packages.



- 45020** Brain Maps with CD

## A Stereotaxic Atlas of the Golden Hamster Brain

**Morin and Wood**

The first golden hamster brain atlas. It provides Nissl and histochemical illustrations and known data about the structure and function of the brain, with labeling of major areas. A CD containing the same illustrations and text is included. Spiral bound.

- 45012** Golden Hamster Brain Atlas +CD

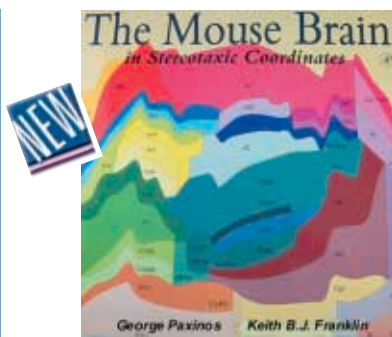

## The Mouse Brain in Stereotaxic Coordinates

**Paxinos and Franklin**

The only stereotaxic atlas in print to depict the mouse brain. Includes 93 high quality and accurate coronal sections and full page pictures, with diagrams illustrating detail and nomenclature. Alternate sections are stained for Nissl and Acetylcholinesterase to illustrate cells and axons. Marker penetrations ensure accuracy of the stereotaxic coordinates.

- 45006** Mouse Brain Atlas + CD

## Atlas of the Developing Rat Nervous System

**Paxinos, et al.-2nd Edition**

Displays section-by-section photographs

and accompanying labeled diagrams of the embryonic and neonatal rat brain. Shows brain development at Embryonic Days 14 (whole embryo), 16, and 19, as well as Postnatal Day 0.

- 45034** Developing Rat Atlas

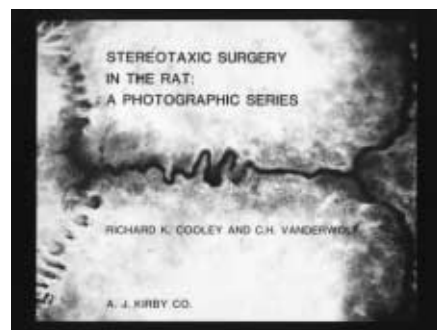

## Stereotaxic Surgery in the Rat: A Photographic Series

Illustrated Step-by-Step Guide

**Cooley and Vanderwolf**

Each step of stereotaxic surgery, from anesthetizing the animal to suturing, is clearly described and illustrated, with full page 8 1/2 x 11 in photomicrographs. The photos employ the "U"-Frame type stereotaxic instrument (Lab Standard™ 51600) and utilize the skull flat and bregma zero point coordinate system. All aspects of the instrument and the technique are clearly described and illustrated. 100 pages.

- 45015** Stereotaxic Surgery

## Atlas of Prenatal Rat Brain Development

**Altman and Bayer**

Ten embryonic ages are presented with 20-35 plates each. Only the highest quality micrographs are used. Plates represent the brain of each age in sagittal and coronal planes. A unique 3-D reconstruction of the brain is presented for each of the ten ages. Computer aided illustrations of brain regions add to the utility of this atlas. A detailed and logical classification of the germinal matrix at early stages is included. 664 pages.

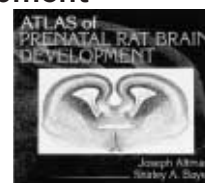

- 45036** Prenatal Rat Brain Atlas

## SCIENTISTS/INVENTORS

We welcome your ideas. If you have developed an instrument, or have an idea for a new product we would like to discuss its production with you.

**Laboratory Animal Anaesthesia**

**Flecknell-2nd Edition**

This handbook provides a basic practical guide to anaesthesia in laboratory animals. Topics covered are the general principles of pre-operative care, anaesthetic techniques, and anaesthetic managements. An introduction to specialized procedures, such as long-term anaesthesia and the use of neuromuscular blocking agents, has also been included.



**45031** Animal Anaesthesia

**The Sheep Brain: A Photographic Series**

**Vanderwolf and Cooley**

An advanced laboratory guide for the study of neuroanatomy using the sheep brain as dissection material. Appendices illustrate histology, function, and brains of common laboratory animals. 8 1/2 x 11 inch paperback, 108 pages.

**45035** The Sheep Brain

**Systematic Approach to Evaluation of Mouse Mutations**

**Sundberg and Boggess, eds.**

Includes the fundamental elements in creating and maintaining colonies of mutant strains of mice, written by renowned experts at the Jackson Laboratory. Other chapters focus on the popular and definitive biochemical and behavioral methods for phenotypic characterization of mutations. 199 pages.

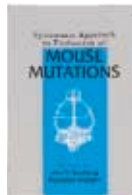

**45050** Mouse Mutations Book

**New Zealand Rabbit's Brain**

**Urban and Richard**

A stereotaxic atlas of the brain of the New Zealand rabbit (1972) with 35 Nissl stained sections on facing pages with labeled diagrams of the same level. The horizontal plane is through the middle of the auditory meatus and the infraorbital margins.

**45018** Rabbit Brain Atlas

**Photographic Atlas of the Rat Brain**

**Kruger, Saporta & Swanson**

A photographic guide to the cell and fiber architecture of the rat brain illustrated in three planes with stereotaxic coordinates. This volume contains 128 photo-micrographs of excellent sections of the rat brain. Each plate has matching cell and fiber stains. Coronal sections at 0.3 mm intervals. With annotations and labeling of structures.

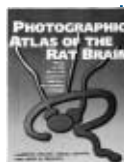

**45025** Atlas of Rat Brain

**The Rhesus Monkey Brain in Stereotaxic Coordinates**

**Paxinos, Huang, and Toga. 1999.**

Comprehensive atlas on the rhesus monkey brain, with 151 photos and 151 line diagrams. The main section of the plates alternates sections stained with Nissl and AChE, and this edition also contains 64 fully labeled photographic plates of antibodies to neurofilament protein.



**45007** Rhesus Monkey Brain Atlas

**Stereotaxic Atlas of the Pig Brain**

**Félix, Léger, and Albe-Fessard. 1997.**

This comprehensive pig brain atlas contains 60 frontal and 18 sagittal labeled drawings, which accompany 21 frontal and 18 sagittal photographs of brain sections. Drawings corresponding to the photographic Nissl-stained (cresyl violet) sections are labeled with respect to radiographic coordinates. 137 pages.

**45009** Pig Brain Stereotaxic Atlas

**A Stereotaxic Atlas of the Grey Lesser Mouse Lemur Brain**

**Bons, et al., 1998.**

This new stereotaxic atlas is the definitive brain reference for *Microcebus murinus*, the grey lesser mouse lemur. The book contains a thorough presentation of the mouse lemur brain using histological (Nissl-stained) plates accompanied by complimentary line drawings, 27 transverse sections from 5 mm anterior, every 0.25 mm, and 53 sagittal sections every 0.2 mm. 173 pages.

**45008** Mouse Lemur Brain Atlas

**The Laboratory Mouse**

**Suckow, et al. 2000**

This book is the latest in the family of reference books for model species. Includes chapters on basic biology, physiological data, laboratory care, housing, veterinary care and husbandry, anesthesia, and diseases and preventative measures. 184 pages.

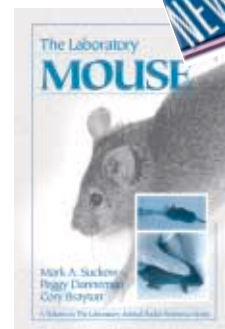

**45041** The Laboratory Mouse

**Atlas of the Prenatal Mouse Brain**

**Schambra, Lauder and Silver**

High quality photomicrographs of brain sections are depicted in sagittal, coronal, and horizontal planes for four gestational age groups. Each photomicrograph is accompanied by a fully labeled, precision-drawn diagram for easy identification of brain structures.

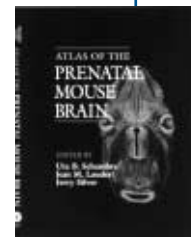

**45033** Prenatal Mouse Atlas

**The Laboratory Rat**

**Sharp and LaRegina**

The premier reference for regulatory compliance, research, facility management, and technical procedures. Features include normative values, anesthesia methods, blood sampling methods, age related lesions, colony health surveillance, and necropsy techniques. Includes husbandry tips, resource lists, and experimental methodologies. It is the most recent comprehensive rat reference book. 214 pages.



**45040** The Laboratory Rat

## SURGICAL ACCESSORIES



### Cautery Pens

*Sterile and Disposable*

Stop bleeding immediately with these handy, sterile, disposable cautery pens. The platinum filaments reach up to 2200° F (low-temp up to 850° F) within milliseconds, to heat-seal cut blood vessels. The tips allow positioning without obstructing the user's view. A locking cap secures the on/off switch to prevent accidental operation, and protects the tip. Economical and disposable; discard the instrument when the built-in batteries are dead. Supplied in packages of 10; each pen in a sterile pouch.

- 59015** Cautery Pens, Low-Temp Tip, 850° F
- 59016** Cautery Pens, High-Temp Tip, 2200° F



### Gemini Cautery System

*Dual Operating Temperatures*

The perfect tool for cauterizing, the battery operated Gemini Cautery System provides two different operating temperatures: 2200° F and 1300° F.

The easily replaceable, autoclavable, Nickel-Chrome tips require less power and provide longer battery life. The convenient battery spacer converts the handpiece from high temperature to low temperature. Comes complete with Standard AA batteries, battery spacer, 2 each Nickel-Chrome tips, sizes 5mm and 10mm, all in a hard plastic case with die cut foam for convenient storage. Replacement tips in packs of 10.

- 59017** Gemini Cautery System
- 59018** Replacement Tips, 5mm (10/box)
- 59019** Replacement Tips, 10mm (10/box)



### Cautery Instrument

**AC Powered**

This line powered cautery instrument maintains desired temperature, from 300° F to 2200° F consistently during tissue contact and does not rapidly diminish.

There is no electrical noise or aberrant radio frequency to cause unintended tissue damage.

The slim autoclavable handpiece, with six-foot cord, is convenient to maneuver into position.

**NEW** Disposable tips for the cautery unit have hollow brass shanks for faster heating. Supplied non-sterile; for

single use. Disposable tips are available in boxes of 10. Replacement tips sold individually.

The instrument comes complete with 2 each of platinum disposable tips, shaped like 'A', 'C', and 'E' (above).

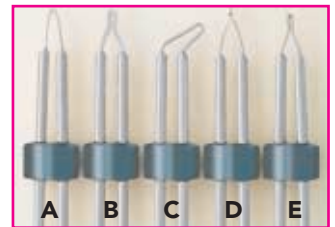

- 59005** Cautery Instrument, complete
- Replacement Tips**
- 59006** Type A Tip
- 59007** Type B Tip
- 59008** Type C Tip
- 59009** Type D Tip
- 59010** Type E Tip
- 59002** Disposable Tip, Shape 'A', box of 10
- 59003** Disposable Tip, Shape 'C', box of 10
- 59004** Disposable Tip, Shape 'E', box of 10
- 59012** Replacement Handpiece
- 59011** Optional Wall or Table Mounting Bracket



## EZ Clip Wound Clips

Non-sterile. Pyrogen free. Length: 9 mm. Packaged within heat-sealed peel-open envelope for cleanliness and ease of handling and storage.

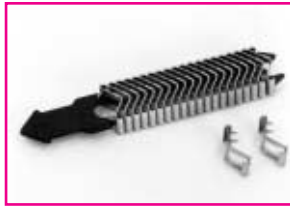

### Autoclavable Packaging

New polypropylene packaging allows for sterilization of wound clips without having to remove clips from wrapper.

- 59022** Non-Sterile EZ Clips, Box of 200
- 59027** Non-Sterile EZ Clips, Case of 1000

## EZ Clip Applier

Stainless-steel applying forceps hold one rack of 20 clips. Use as you would a staple gun to apply clips to wound. Clips fed by rustless beryllium-copper springs.



- 59023** EZ Clip Applier

## EZ Clip Remover

Easily removes clips from healed wound. Stainless steel.



- 59026** EZ Clip Remover



59020 EZ Clip™ Kit

## EZ Clip Wound Closing Kit

### For Rapid Suturing with Minimum Trauma

Ideal for use with lab animals or in veterinary surgery. The EZ Clip kit consists of the 59023 EZ Clip Applier, case of Wound Clips and the 59026 EZ Clip Remover.

Use applier as you would a staple gun to rapidly close the wound. It provides maximum holding force with minimal trauma. No need for assistance. When wound is healed, clips remove easily with 59026 clip remover.



Racks of 20 clips are individually packaged in autoclavable polypropylene for ease of handling and storage.

- 59020** EZ Clip Kit

## Sutures

Monofilament nylon, braided silk (permanent) sutures, and chromic gut and synthetic absorbable sutures, are now available from Stoelting. All in packages of 12, with semicircular (cutting) needles.



	Size	Length	Cat. No.
Nylon	4-0	36"	50480
Monofilament	3-0	36"	50481
Blue	2-0	36"	50482
Monomid Nylon	5-0	18"	50483
Non-Absorbable	4-0	18"	50484
	3-0	18"	50485
	2-0	18"	50486
Silk Braided	5-0	18"	50487
Non-Absorbable	4-0	18"	50488
	3-0	18"	50489
	2-0	18"	50490
Natural	4-0	27"	50491
Chromic-Gut	3-0	27"	50492
	2-0	27"	50493
	0	27"	50494
Visorb (PGA)	4-0	18"	50496
Synthetic	3-0	18"	50497
Absorbable	2-0	18"	50498

## Surgical Shavers



The Andis AG clippers run quiet and cool, without the need for vent holes that could take in hair and dander. The durable housing remains cool to the touch even after long operation.

The blade assemblies are detachable and can be changed quickly. The blade sets are interchangeable between Oster A-5 and the Andis AG clippers. Andis blades are made of high carbon steel, hardened for long cutting life. Provided with a #40 surgical blade. Available in 110 or 220 Volt models.

**Ultrafine (to 0.1mm) blade for mice is now available.**

- 51480** Surgical Shaver 110V
- 51481** #10 Trimming Blade
- 51482** #40 Surgical Blade
- 51483** Ultrafine Blade

See page 80  
For New Low-  
Cost Tail Flick  
Analgesia  
Instrument



## Cordless Clippers

This rechargeable clipper is as powerful, and uses the same blade set, as the Andis AG clippers (above). Can

shave any size animal for surgery, and last all day on a single charge.

Fast recharger stand recharges clippers in one hour or less, but will not damage batteries when left on charge for long periods. Battery Pack can be removed from the clipper for recharging, and a spare Battery Pack can be used for high volume applications.

Comes with Recharger Stand, batteries, #10 trimming blade and #40 surgical blade.

**Ultrafine (to 0.1mm) blade for mice is now available.**

- 51465** Rechargeable Cordless Clippers, Heavy Duty, Complete
- 51466** Replacement Charger Stand
- 51467** Spare Battery Pack
- 51481** Blade, Trimming #10, AG
- 51482** Blade, Trimming #40, AG
- 51483** Ultrafine Blade

## Hair and Dander Vacuum for Shavers

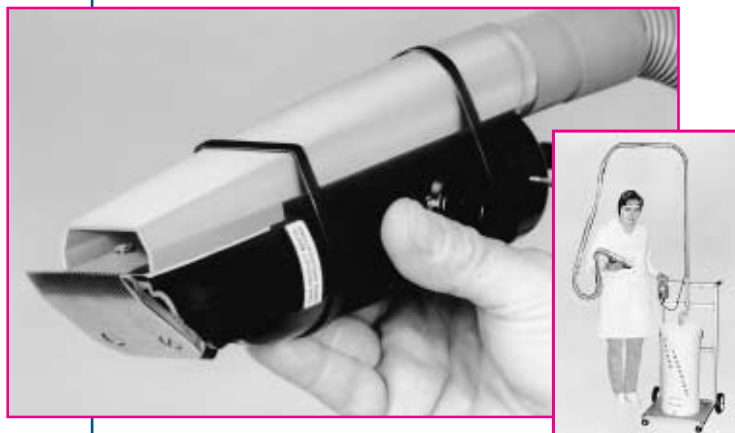

The Hair and Dander Vacuum attaches to most Oster and Andis clippers (not included), including the Andis AG (51480 above) and the Oster A5. Hair and dander are vacuumed away as soon as they are cut, then collected in a small portable vacuum cleaner.

The vacuum cleaner is equipped with a paper bag and a cloth filter backed by a HEPA filter. This combination is 99.97% efficient to 0.3 microns, without excessive filter replacement costs. The exhaust to the room is only clean air.

The paper bag filters have a capacity of 8.3 dry quarts. The HEPA filter can accumulate 2.7 dry quarts capacity. The system comes complete with the vacuum cleaner on a cart, the clipper attachment head, and 3 paper bag filters.

- 51490** Hair & Dander Vacuum for Shavers
- 51493** Replacement HEPA Filter
- 51492** Replacement Paper Bag Filter, pkg. of 10

# Homeothermic Blankets for Rodents

**Feedback Regulated  
Maintenance of Body Temperature**

This Homeothermic Blanket and temperature control system is designed to actively maintain an animal's body temperature at a pre-set target value. A thermistor probe provides feedback to the controller about the animal's core body temperature. The controller adjusts current to the heating pad as needed to maintain the desired body temperature.

**No Broadcasting of Electrical Noise**

The proportional DC power supply slowly varies current output to the heating element, based on the resistance of the monitoring thermistor probe. As a result, AC noise and current fluctuations are eliminated.

**Digital Display**

Three digit LED display on the front panel indicates the temperature in tenths of a degree C.

Thermistor probe and heating pad plug into a junction box, which connects to controller via a 2.5 m shielded cable. Heating pads for other species are interchangeable with instrument. May be conveniently rack mounted.

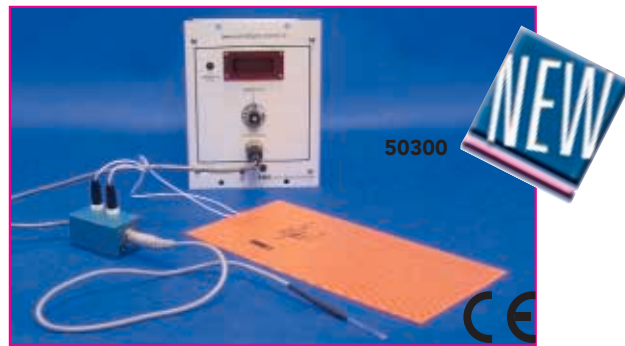

**Now available: Extra Small Heating Pad accessory. It perfectly fits Stoelting's 51625 Cunningham™ Mouse and Neonatal Rat Adaptor (see page 5).**

See 'Animal Surgery' on our website for complete specifications.

**50300** Homeothermic Blanket System  
(Includes controller, cable, probe, and medium heating pad)

**Optional Heating Pads**

- 50305** New! Extra Small Heating Pad (65 x 95 mm)
- 50301** Small Heating Pad (100 x 125 mm)
- 50302** Medium Heating Pad (125 x 250 mm)
- 50303** Large Heating Pad (250 x 250 mm)
- 50304** Replacement Temperature Probe

**New  
Low-Cost  
Rota-Rod  
Treadmill  
See page  
73**

# Hot Glass Bead Dry Sterilizer

**Dry Sterilize Surgical Instruments in Seconds—Meets New NIH Guidelines**

Insert the cleaned surgical instrument, leave for 2-5 seconds, and remove. Within 30 seconds, the surgical instruments are cool enough to use.

**Stays Cool to the Touch**

The chassis stays cool, even at the end of a full day of operations. The air above the unit is cool enough to insert an instrument into the well without discomfort. Sterilization of the inserted parts by dry heat (250° C) takes 2-5 seconds. The working end is sterile before the handles get hot.

**Small Footprint**

The sterilizer's small size fits conveniently into the back corner of a hood or surgical table. One package of glass beads is included with the instrument.

**Specifications**

Warm Up Time.....	20 Min.
Working Temperature .....	250° C (approx. 500° F)
Sterilization Time.....	2-5 sec



- 50287** Dry Sterilizer
- 50289** Glass Bead Refill Package

**See page 25  
for EZ Clips.**



Save time!  
Worldwide  
quotations  
(including  
shipping  
charges)  
available  
online.

## EchoTherm Hot Plate/Stirrers

Heat, stir, or do both on these flat, ceramic heater surfaces

- Two models available: Digital or Analog
- Ceramic, chemically-resistant heater top for quick heating

The EchoTherm Hot Plate/Stirrers are easy to operate and perfect for every lab where precise measurements of heating and stirring are necessary.

### Two models are available

#### Digital

On the digital model, temperature measurement of a solution is accurate to  $\pm 1^\circ\text{C}$  over the entire temperature range of  $450^\circ\text{C}$ . Calibration of temperature is electronic and stored in memory. In addition, the instrument features PID temperature control for tight sample control.

#### Analog

Its heater control has quick-set "HI", "LO", and "OFF" positions for quick setting, or manually set from 0 to  $450^\circ\text{C}$ . This control will regulate a set point to  $\pm 2.5^\circ\text{C}$ . The stirrer control is continuous over 270 degrees of rotation from minimum to maximum speed.

The stirrer components of both models are capable of stirring at rates from 100 to 1500 rpm, and the magnet is a circular disc with twenty pound pull strength.

The ceramic heater tops are made of a brilliant white, flat surface framed in cast aluminum to shield heat from the edge of the plate. This frame is easy to clean and protected from chemical spills.

These tops have efficient 600-watt heaters that can raise the plate surface temperature to  $450^\circ\text{C}$  in just a couple of minutes.



50283 Digital Hot Plate/Stirrer and 50282 Analog Hot Plate/Stirrer (inset)

Complete specifications available online  
at [www.stoeltingco.com/physio](http://www.stoeltingco.com/physio)

The chassis is cast aluminum to keep spills and heat out of the electronics, and is coated with chemically resistant epoxy based paint for durability.

All units come complete with a six-foot long, three wire grounded, detachable line cord, fuse holder, and main ON-OFF switch.

The Hot Plate/Stirrers are UL, CSA, and CE certified.

- 50283 EchoTherm Digital Hot Plate/Stirrer
- 50282 EchoTherm Analog Hot Plate/Stirrer

## Instrument Cup

Save 50 - 70% on  
Surgical Instruments  
Pages 30-45



Stoelting, an instrument cup designed to arrange surgical instruments in the open position.

**Made of durable silicone, the Instrument Cup replaces glass and metal instrument pans, and won't damage delicate instrument tips.** Large instruments rest against the bottom and side, while small instruments may be suspended from the scalloped brim.

When using sterilization solution (e.g., Cidex) for disinfecting instruments, be sure to change liquid regularly.

The instrument cup has a wide base (5 in) for stability, making it resistant to slippage on table surface.

- 52194 Instrument Cup



## Fiber-Lite® Illuminator

Approved for the World Market by UL, CE

Fiber optic illumination lets you conduct light to where it is needed, and leave electrical interference, heat, and fan vibration behind.

This makes it an excellent source of intense, focused or diffuse light for stereomicroscopy, small animal surgery, or any detail work.

**The Fiber Lite Comes with the popular Dual-Pipe Fiber Optic attachment.** The Dual-Pipe Fiber Optic allows the operator to supply light from both sides, to eliminate shadows and mounts directly on the 150 watt illuminator, without adaptors. The keyed output port prevents rotation or wobbling of the fiber optic assembly. Pipes may be positioned on the same side, for greater intensity. Each pipe is 23" long.

See 'Fiber Optics' on our website for complete specifications.

- 59259** Standard Illuminator (Includes Dual-Pipe Fiber Optic)
- 59260** Illuminator Body Only
- 59262** Dual-Pipe Fiber Optic Only
- 59208** Polarizing Lens Attachment

## Constant Light and Color Illuminator

The Choice for Color Photography or Machine Vision Applications

The most demanding fiber optic illumination applications require constant color, independent of intensity level (for color photography) or constant intensity of illumination for machine vision applications.

The current to the bulb is DC to prevent the 60 cycle oscillations in output level found in any bulb operated on AC current. These oscillations are not visible to the eye, but are visible to optical sensors, high speed films, and photocells.

A manual iris permits adjusting the intensity of the light for reproducible color photography. This high-performance illuminator also has a remote intensity

control input, and a built-in filter holder for special color effects.

The Constant Light and Color Illuminator comes with the popular Dual-Pipe Fiber Optic attachment.

Also included is an infrared filter installed for removing heat from the light. An optional Filter Kit includes a filter for correction to daylight, and blue, green, yellow, red filters. A filter insertion tool is also included, for your convenience.

See 'Fiber Optics' on our website for complete specifications.



- 59279** Constant Light and Color Illuminator (Includes Dual-Pipe Fiber Optic)
- 59256** Color Filter Kit
- 59208** Polarizing Lens Attachment



### Dual-Pipe Fiber Optic

Dual pipes allow the operator to supply light from both sides, to eliminate shadows, or both outlets may be positioned on the same side, for greater intensity. Each pipe is 23" long. Illuminator not included.

- 59262** Dual-Pipe Fiber Optic



### Forked Fiber Optics

For entry into Faraday Cage, or for long travel distance. A stand is included for support. 2 Focusing lenses are included. Illuminator not included.

- 59263** Forked Fiber Optic Bundles



### Single-Pipe Fiber Optic

A single-pipe fiber optic with self-supporting stainless steel monocoil with a focusing lens, fits either illuminator. Illuminator not included.

- 59261** Single Fiber Optic Bundles

Fiber Optics



### Fiber Optic Lite Pipets

The kit contains 6 probes: one 90°, one 45°, with 2.77 mm diameter and four straight probes with diameters of 1.08, 1.78, 2.77, & 3.76 mm.

- 59265** Lite Pipets Kit

## Your Choice of the Most Popular Surgical Instruments

### Surgical Instruments

Forceps & Tweezers . . . . .	31-35
Clips & Clamps . . . . .	36
Retractors . . . . .	37
Spring Scissors . . . . .	38
Micro Dissecting Scissors . . . . .	39
Operating Scissors . . . . .	40
Bone Rongeurs . . . . .	42
Bone Cutting Forceps . . . . .	43
Scalpels . . . . .	44
Needle Holders . . . . .	45

### Related Instruments

Anesthesia Instruments . . . . .	50-53
EZ Clip Wound Closing Instruments . . . . .	25
Rodent Surgery Table . . . . .	25
Homeothermic Blankets . . . . .	27
Dry Sterilizer . . . . .	27
Cautery Pens . . . . .	24
Surgical Shavers . . . . .	26



### Save 70% or more on Stoelting Surgical Instruments

Stoelting Surgical Instruments, made of stainless steel, utilize German technology to produce surgical instruments of quality comparable to those made in Europe...at a fraction of the cost.

These instruments have excellent "feel" and accuracy. Their durability and reliability make them an excellent choice for general animal surgery.

Save more than 70% and your satisfaction is guaranteed! If you are not satisfied, your money will be immediately refunded . . . no questions, no hassle.



### Dumont Forceps are offered in a variety of materials

**Inox:** Inox is a specific stainless alloy composed of carbon steel and chromium. Inox tips are more flexible than pure carbon steel but not as hard (Rockwell 55). Inox has good stain resistance and is magnetic.

**Dumoxel:** Dumoxel is even more stain resistant than Inox and is highly corrosion resistant. With a Rockwell 36 at the tips, tweezers made from this alloy have very soft, flexible tips. Dumoxel is non-magnetic and exhibits high temperature resistance.

**Dumostar:** This new alloy is a blend of steel, chromium, nickel, and cobalt and has many of the best features of the other alloys. Dumostar is heat resistant to over 500°C and is completely non-magnetic. Dumostar is extremely corrosion resistant and is one of the harder alloys at Rockwell 62.

However, because of its unique composition, Dumostar tips are very flexible, are resistant to fatigue, and are capable of flexing far beyond other alloys without permanently deforming. This alloy is far superior in overall performance than any other material available today!



### Roboz instruments are made of stainless steel.

**Stainless Steel:** The common name for various alloys composed of carbon steel and chromium. Stainless steel exhibits good stain resistance and has varying degrees of magnetism.

Most tweezers are available in two tip styles, namely "standard" and "biologie". The dimensions of each vary by pattern. In general, the "biologie" tips are about twice as fine as the "standard" tips. Tip widths are listed for each instrument.



## Dumont® Forceps

Products shown actual size



Patterns 1, 2 and 3

PATTERN	LENGTH	TIP	TIP PROFILE	MATERIAL	CAT. NO.
1	120 mm	.20 X .12 mm		INOX	52100-11
1	120 mm	.20 X .12 mm		Dumostar	52100-17
2	120 mm	.34 X .14 mm		INOX	52100-21
2	120 mm	.34 X .14 mm		Dumostar	52100-27
3	120 mm	.17 X .10 mm		INOX	52100-31
3	120 mm	.17 X .10 mm		Dumostar	52100-37
3	120 mm	biologie: .08 X .04 mm		Dumostar	52100-38

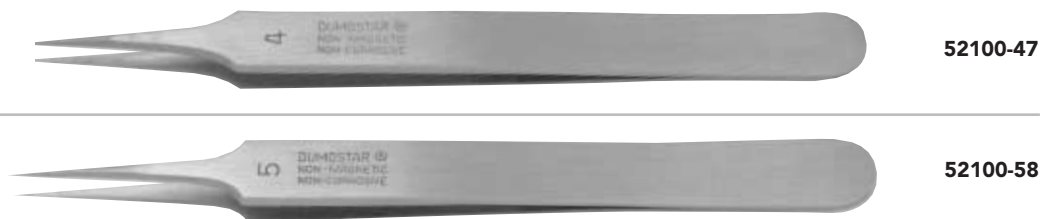

Patterns 4 and 5

PATTERN	LENGTH	TIP	TIP PROFILE	MATERIAL	CAT. NO.
4	110 mm	.13 X .08 mm		INOX	52100-41
4	110 mm	.13 X .08 mm		Dumostar	52100-47
4	110 mm	biologie: .06 X .02 mm		Dumostar	52100-48
5	110 mm	.10 X .06 mm		INOX	52100-51
5	110 mm	.10 X .06 mm		Dumoxel	52100-53
5	110 mm	.13 X .08 mm		Dumostar	52100-55
5	110 mm	.10 X .06 mm		Dumostar	52100-57
5	110 mm	biologie: .05 X .01 mm		Dumostar	52100-58



Patterns 5B, 6 and 7

PATTERN	LENGTH	TIP	TIP PROFILE	MATERIAL	CAT. NO.
5B	109 mm	45° angle: .05 X .01 mm		INOX	52100-52
6	115 mm	.17 X .10 mm		INOX	52100-61
7	115 mm	.17 X .10 mm		INOX	52100-71
7	115 mm	.17 X .10 mm		Dumostar	52100-77

Products shown actual size

## Micro-Dissecting Forceps

Length, balance, spring action and tip type are perfectly matched

**52104-30**  
Micro ADSON



**52104-31**  
Brown ADSON



**52104-32**  
Micro ADSON

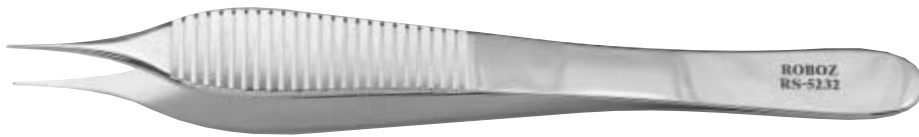

**52104-33**  
ADSON



**52104-34**  
ADSON



NAME	LENGTH	TIP	CAT. NO.	CAT. NO.	PRICE
Micro ADSON	4.75 in (120 mm)	0.5 mm, fine, serrated	<b>52104-30</b>	<b>52104-30S</b>	\$23.00
Brown ADSON	4.75 in (120 mm)	Side grasping, 7X7 teeth	<b>52104-31</b>		
Micro ADSON	4.75 in (120 mm)	0.5 mm, fine, 1X2 teeth	<b>52104-32</b>		
ADSON	4.75 in (120 mm)	1 mm, serrated, 1X2 teeth	<b>52104-33</b>		
ADSON	4.75 in (120 mm)	1.3 mm, 2X3 teeth	<b>52104-34</b>	<b>52104-34S</b>	\$22.00
ADSON	4.75 in (120 mm)	1 mm, 1X2 teeth	<b>52104-35</b>	<b>52104-35S</b>	\$17.00

**52106-40**  
SEMKEN



NAME	LENGTH	TIP	CAT. NO.	CAT. NO.	PRICE
SEMKEN	5 in	1.2 mm, serrated	<b>52106-40</b>	<b>52106-40S</b>	\$12.00
SEMKEN	5 in	1.2 mm, 1X2 teeth	<b>52106-42</b>	<b>52106-42S</b>	\$13.00
SEMKEN	5 in	2.0 mm, 2X3 teeth	<b>52106-44</b>	<b>52106-44S</b>	\$15.00

Prices and Catalog Numbers for Stoelting Instruments are shown in magenta.

# Micro-Dissecting Forceps

Products shown actual size



52102-30



52102-32  
Extra Fine



52102-35



52102-36  
Extra Fine



52102-37



52102-38  
Extra Fine

DESCRIPTION	LENGTH	TIP WIDTH	CAT. NO.	CAT. NO.	PRICE
Straight, serrated	4 in	0.8 mm	52102-30	52102-30S	\$17.00
Extra fine, straight, serrated	4 in	0.5 mm	52102-32		
Slight curve, serrated	4 in	0.8 mm	52102-35	52102-35S	\$17.50
Extra fine, slight curve, serrated	4 in	0.5 mm	52102-36		
Full curve, serrated	4 in	0.8 mm	52102-37	52102-37S	\$18.50
Extra fine, full curve, serrated	4 in	0.5 mm	52102-38		
Straight, fine, serrated	4 in	0.8 mm	52102-41		
Straight, fine, serrated	4.5 in	0.8 mm	52102-42		



52102-54  
Moloney



52102-72  
BONN  
with Tying Platform

DESCRIPTION	LENGTH	TIP WIDTH	CAT. NO.
MOLONEY, slight curve, serrated	4.15 in	—	52102-54
BONN, 1X2 teeth, tying platform	3.75 in	0.12 mm	52102-72

Visit  
Stoelting's  
award-  
winning  
website



Products shown actual size

## Tissue Forceps

52108-60



52108-80



Visit our website for surgical supplies

DESCRIPTION	LENGTH	TEETH	CAT NO.	CAT. NO.	PRICE
Tissue Forceps	4.5 in	1 X 2	52108-60	52108-60S	\$9.00
Tissue Forceps	5.0 in	1 X 2	52108-62	52108-62S	\$9.00
Tissue Forceps	5.5 in	1 X 2	52108-64	52108-64S	\$9.75
Tissue Forceps	6.0 in	1 X 2	52108-66	52108-66S	\$11.50
Tissue Forceps	5.0 in	3 X 4	52108-80	52108-80S	\$14.00
Tissue Forceps	3.0 in	Serrated	52108-82		
Tissue Forceps	5.0 in	Serrated	52102-83		
Tissue Forceps	6.0 in	3 X 4	52108-84	52108-84S	\$17.00

## Fixation Forceps

52109-60 KUEHNE



52109-20 BABCOCK



Prices and Catalog Numbers for Stoelting Instruments are shown in magenta.

DESCRIPTION	LENGTH	CAT. NO.	CAT. NO.	PRICE
KUEHNE, flat jaw, angled	4 in	52109-60		
BABCOCK, jaw width: 6 mm	5.5 in	52109-20	52109-20S	\$57.50
BABCOCK, jaw width: 9 mm	6.25 in	52109-22	52109-22S	\$57.50

# Hemostatic Forceps

Products shown actual size



**52110-12**  
**HALSTED Mosquito**

See pages 50-53 for everything you need for small animal anesthesia

DESCRIPTION	LENGTH	CAT. NO.	CAT. NO.	PRICE
HALSTED Mosquito, straight	5 in	52110-10	52110-10S	\$17.00
HALSTED Mosquito, curved	5 in	52110-11	52110-11S	\$17.00
HALSTED Mosquito, extra delicate, straight	5 in	52110-12	52110-12S	\$23.00
HALSTED Mosquito, extra delicate, curved	5 in	52110-13	52110-13S	\$23.00

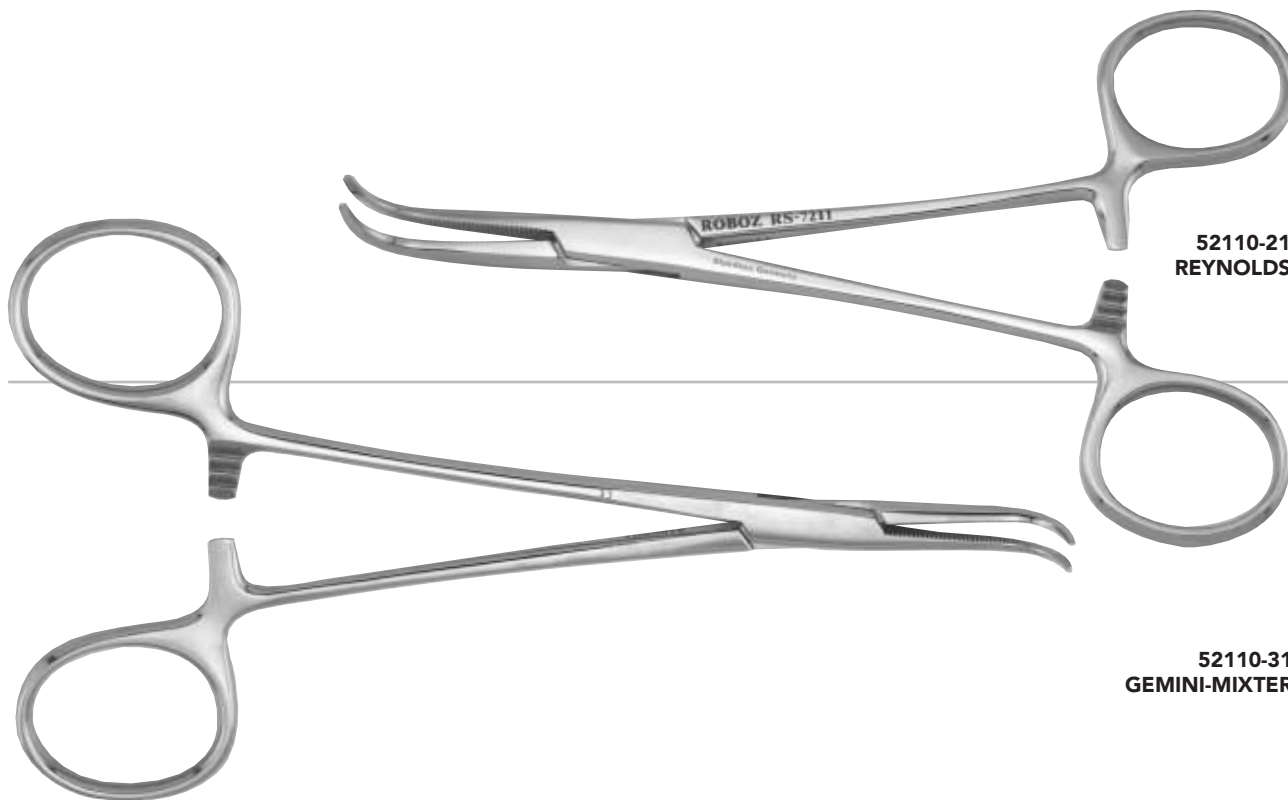

**52110-21**  
**REYNOLDS**

**52110-31**  
**GEMINI-MIXTER**

DESCRIPTION	LENGTH	CAT. NO.	CAT. NO.	PRICE
REYNOLDS, full curve	5 in	52110-21		
GEMINI-MIXTER, full curve, delicate	5.5 in	52110-31	52110-31S	\$35.00

Products shown actual size

## Micro Vascular Clips



52120-00



52120-02



52120-04

VESSEL DIAMETER	OCLUSION PRESSURE	LENGTH	CAT. NO.
1 mm	10-15 gr	8 mm	52120-00
1-2 mm	15-20 gr	11 mm	52120-02
2-3 mm	20-30 gr	14 mm	52120-04

## Micro Clip Setting Forceps

52120-06

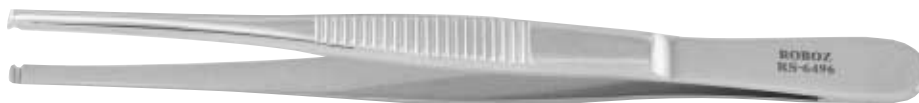

DESCRIPTION	LENGTH	CAT. NO.
Micro Clip Forceps	4.75 in	52120-06

## Micro Clamps



52120-38 DIETRICH



52120-39 DIETRICH

DESCRIPTION	JAW LENGTH/WIDTH	LENGTH	CAT. NO.
DIETRICH Micro Bulldog Clamp, Straight	8 mm/1.2 mm	2 in	52120-38
DIETRICH Micro Bulldog Clamp, Curved	8 mm/1.2 mm	2 in	52120-39
HOPKINS, Bulldog Clamp, Straight	8 mm/1.2 mm	1.5 in	52120-40
HOPKINS, Bulldog Clamp, Curved	8 mm/1.2 mm	1.5 in	52120-42

## Towel Clamps

52122-80  
BACKHAUS



NAME	LENGTH	CAT. NO.	CAT. NO.	PRICE
BACKHAUS	3.5 in	52122-80	52122-80S	\$17.00
BACKHAUS	5.25 in	52122-84	52122-84S	\$18.00

Prices and Catalog Numbers for Stoelting Instruments are shown in magenta.





## Micro-Dissecting Retractors

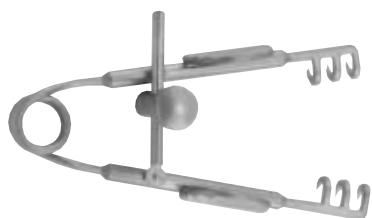

52124 AGRICOLA

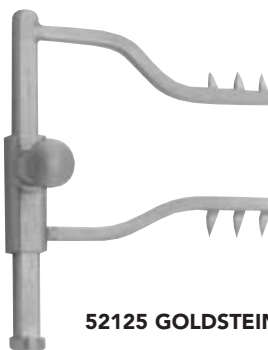

52125 GOLDSTEIN



52126-10 ALM

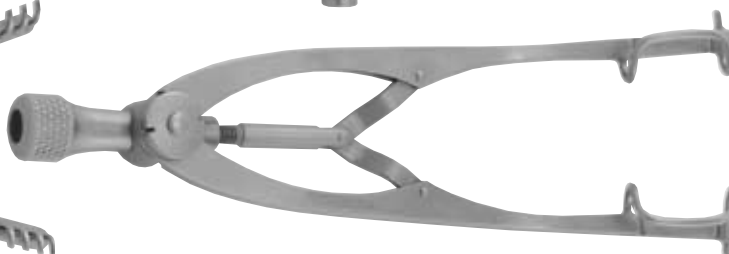

52127 CASTROVIEJO  
non-magnetic

See page 24  
for new  
cautery  
instruments

NAME	PRONGS	DEPTH	SPREAD	LENGTH	CAT. NO.
AGRICOLA	3 X 3	4 mm	1 in	1.5 in	52124
GOLDSTEIN	3 X 3	5 mm	0.75 in	1 in	52125
ALM	4 X 4	3 mm	2.25 in	2.75 in	52126-10
ALM	4 X 4	13 mm	3 in	4 in	52126-14

NAME	BLADE LENGTH/DEPTH	SPREAD	LENGTH	CAT. NO
CASTROVIEJO	15 mm/5 mm	35 mm	3.75 in	52127

## Retractors

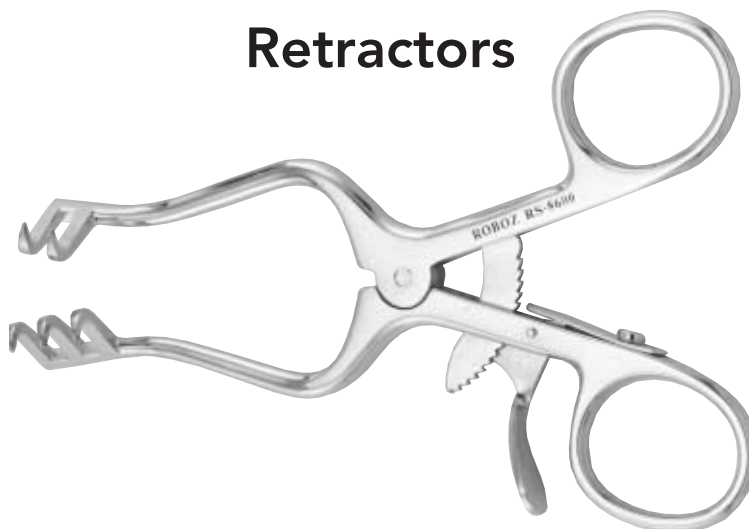

52128-00  
WEITLANER

Shown actual size

Visit our  
award-  
winning  
website  
for our  
newest  
products

NAME	PRONGS	SPREAD	LENGTH	CAT. NO.	CAT. NO.	PRICE
WEITLANER	2 X 3, sharp	1.5 in	4 in	52128-00	52128-00S	\$89.00
WEITLANER	2 X 3, blunt	1.5 in	4 in	52128-02	52128-02S	\$89.00
WEITLANER	3 X 4, blunt	1.75 in	5.5 in	52128-12	52128-12S	\$95.00
WEITLANER	3 X 4, blunt	3.5 in	6.5 in	52128-14	52128-14S	\$105.00

Products shown actual size

## Spring Scissors

52130-00  
MCPHERSON-VANNAS



52130-01  
MCPHERSON-VANNAS



NAME	CUTTING EDGE	TIP WIDTH	LENGTH	CAT. NO.	PRICE
MCPHERSON-VANNAS	straight, 5 mm	0.2 mm	3 in	<b>52130-02</b>	
MCPHERSON-VANNAS	curved, 5 mm	0.2 mm	3 in	<b>52130-03</b>	
MCPHERSON-VANNAS	straight, 5 mm	0.3 mm	3 in	<b>52130-00</b>	
MCPHERSON-VANNAS	curved, 5 mm	0.3 mm	3 in	<b>52130-01</b>	
MCPHERSON-VANNAS	straight, 6 mm	0.3 mm	4 in	<b>52130-30</b>	
MCPHERSON-VANNAS	curved, 6 mm	0.3 mm	4 in	<b>52130-31</b>	

52130-18  
VANNAS



52130-19  
VANNAS



52130-58  
CASTROVIEJO



NAME	CUTTING EDGE	TIP WIDTH	LENGTH	CAT. NO.	CAT. NO.	PRICE
VANNAS	straight, 3 mm	0.2 mm	3 in	<b>52130-20</b>		
VANNAS	curved, 3 mm	0.2 mm	3 in	<b>52130-21</b>		
VANNAS	straight, 3 mm	0.3 mm	3 in	<b>52130-10</b>		
VANNAS	curved, 3 mm	0.3 mm	3 in	<b>52130-11</b>		
VANNAS	angled on edge, 3 mm	0.3 mm	3 in	<b>52130-18</b>		
VANNAS	angled on flat, 3 mm	0.3 mm	3 in	<b>52130-19</b>		
CASTROVIEJO	straight, 9mm	0.3 mm	3.5 in	<b>52130-50</b>		
CASTROVIEJO	angled, 9 mm	0.3 mm	3.5 in	<b>52130-58</b>	<b>52130-58S</b>	<b>\$118.00</b>

Perfect for  
precise surgical  
procedures  
where space is  
very restricted

Prices  
and Catalog  
Numbers  
for Stoelting  
Instruments  
are shown  
in magenta.

## Micro Dissecting Scissors

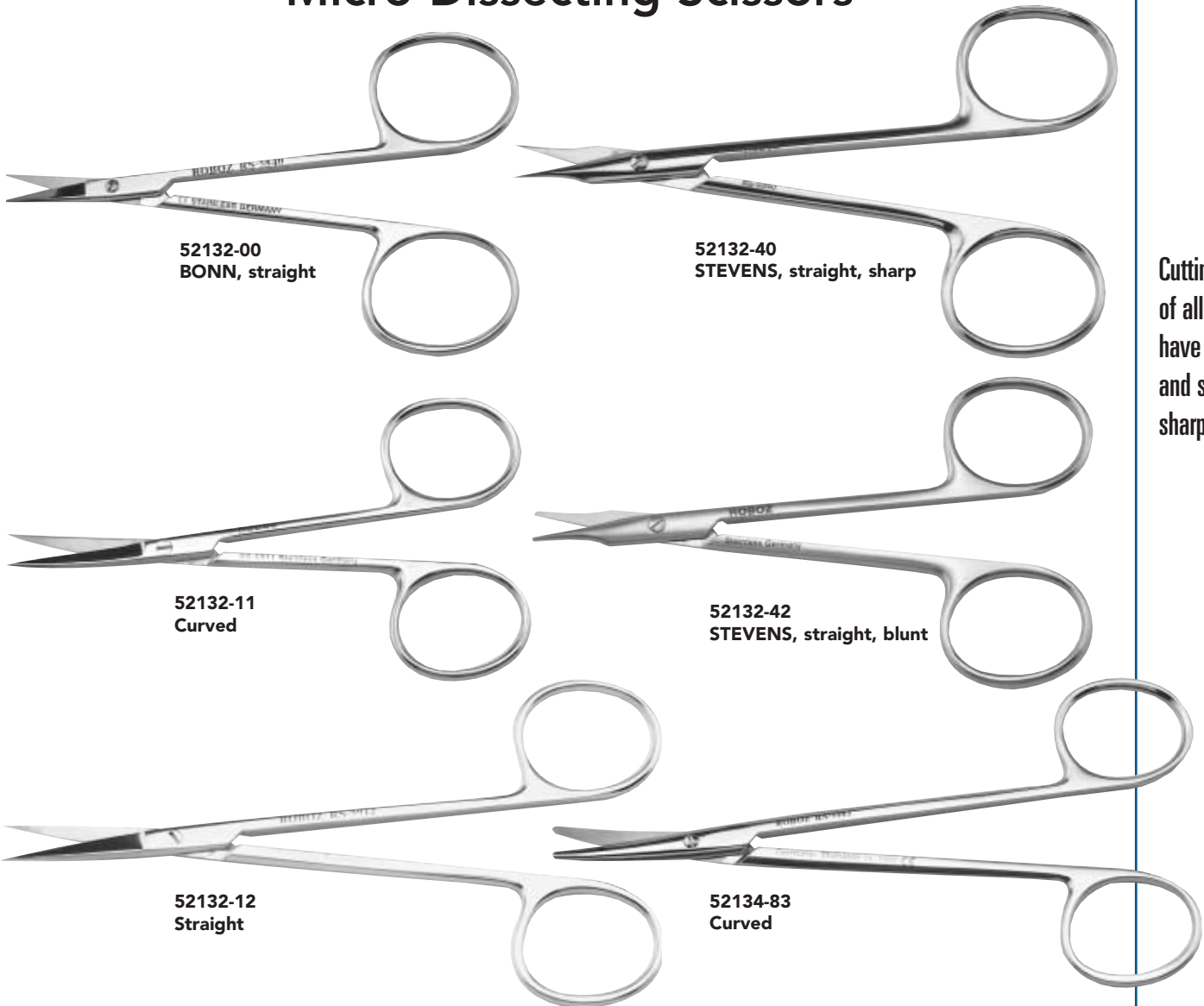

Cutting edges of all scissors have long life and superior sharpness.

DESCRIPTION	BLADE LENGTH	UNIT LENGTH	CAT. NO.	CAT. NO.	PRICE
BONN, straight	15 mm	3.5 in	52132-00		
BONN, curved	15 mm	3.5 in	52132-01		
straight, sharp	20 mm	3.5 in	52132-02		
curved, sharp	20 mm	3.5 in	52132-03		
straight, sharp	23 mm	3.5 in	52132-10		
curved, sharp	23 mm	3.5 in	52132-11		
straight, sharp	24 mm	4.5 in	52132-12	52132-12S	\$28.50
curved, sharp	24 mm	4.5 in	52132-13	52132-13S	\$28.00
STEVENS, straight, sharp	19 mm	4.25 in	52132-40		
STEVENS, curved, sharp	19 mm	4.25 in	52132-41		
STEVENS, straight, blunt	19 mm	4.25 in	52132-42		
STEVENS, curved, blunt	19 mm	4.25 in	52132-43		
straight, blunt	25 mm	4.5 in	52134-82	52134-82S	\$31.00
curved, blunt	25 mm	4.5 in	52134-83	52134-83S	\$31.00
straight, blunt carbide	25 mm	4.5 in	52134-84		
curved, blunt carbide	25 mm	4.0 in	52134-85		
straight, sharp/blunt	30 mm	4.75 in	52134-94		
straight, probe points	26 mm	4.0 in	52134-90		



Products shown actual size

## Operating Scissors



52134-92

### LIGHT OPERATING — Sharp/Sharp

BLADE	LENGTH	CAT. NO.	CAT. NO.	PRICE
straight, 30 mm	4.75 in	52134-92	52134-92S	\$31.00
curved, 30 mm	4.75 in	52134-93	52134-93S	\$31.00

### REGULAR OPERATING — Sharp/Sharp

BLADE	LENGTH	CAT. NO.	CAT. NO.	PRICE
straight	4.5 in	52138-02	52138-02S	\$20.00
straight	5.0 in	52138-08	52138-08S	\$20.50
straight	5.5 in	52138-14	52138-14S	\$23.00
straight	6.0 in	52138-20	52138-20S	\$23.00
straight	6.5 in	52138-26	52138-26S	\$24.00

### REGULAR OPERATING — Sharp/Sharp, continued

BLADE	LENGTH	CAT. NO.	CAT. NO.	PRICE
curved	4.5 in	52138-39	52138-39S	\$22.00
curved	5.5 in	52138-45	52138-45S	\$23.50
curved	6.5 in	52138-51	52138-51S	\$28.00

Excellent  
"feel" and  
handling

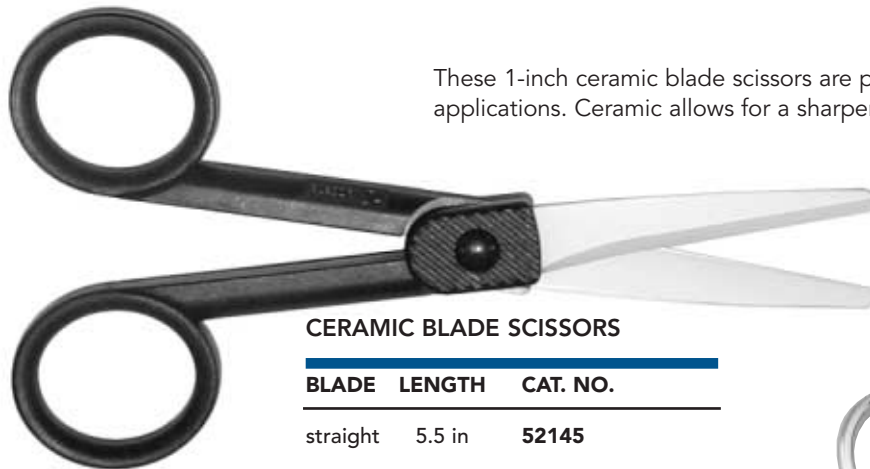

These 1-inch ceramic blade scissors are perfect for the most precise applications. Ceramic allows for a sharper edge than stainless steel.

### CERAMIC BLADE SCISSORS

BLADE	LENGTH	CAT. NO.
straight	5.5 in	52145

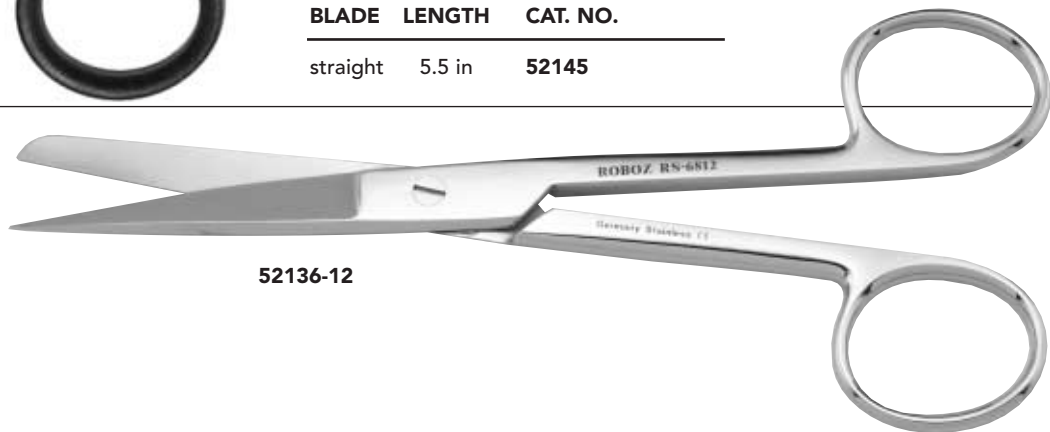

52136-12

### REGULAR OPERATING — Sharp/Blunt

BLADE	LENGTH	CAT. NO.	CAT. NO.	PRICE
straight	4.5 in	52136-00	52136-00S	\$20.00
straight	5.0 in	52136-06	52136-06S	\$20.50
straight	5.5 in	52136-12	52136-12S	\$21.00
straight	6.0 in	52136-18	52136-18S	\$23.00
straight	6.5 in	52136-24	52136-24S	\$24.00

### REGULAR OPERATING — Sharp/Blunt, continued

BLADE	LENGTH	CAT. NO.	CAT. NO.	PRICE
straight	7.0 in	52136-30	52136-30S	\$28.00
curved	4.5 in	52136-37	52136-37S	\$22.00
curved	5.5 in	52136-43	52136-43S	\$23.50
curved	6.5 in	52136-49	52136-49S	\$28.00

Prices  
and Catalog  
Numbers  
for Stoelting  
Instruments  
are shown  
in magenta.



# Operating Scissors

Products shown actual size



52140-40

**VETERINARY HEAVY PATTERN —**  
Serrated 57 mm Blade

BLADE	LENGTH	CAT. NO.
straight, sharp/blunt	6.5 in	52140-40
curved, sharp/blunt	6.5 in	52140-41
straight, blunt/blunt	6.5 in	52140-42
curved, blunt/blunt	6.5 in	52140-43

Need a surgical instrument you can't find?

We'll find it for you.



## MAYO SCISSORS

BLADE	LENGTH	CAT. NO.
straight, 43 mm	5.5 in	52140-70
straight, 43 mm Sure Cut	5.5 in	52140-71

52142-59  
**METZENBAUM (LAHEY),**  
curved, extra delicate

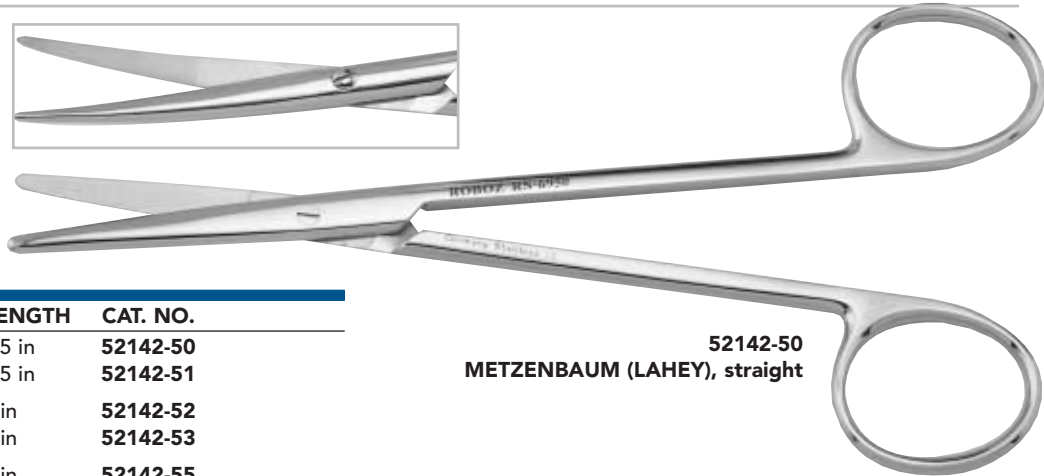
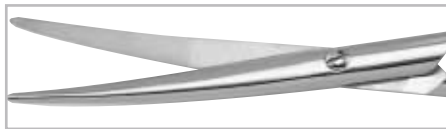

52142-50  
**METZENBAUM (LAHEY), straight**

## METZENBAUM (LAHEY)

BLADE	LENGTH	CAT. NO.
straight, 39 mm	5.5 in	52142-50
curved, 39 mm	5.5 in	52142-51
straight, 35 mm	7 in	52142-52
curved, 35 mm	7 in	52142-53
carbide, curved, 35 mm	7 in	52142-55
carbide, curved, 32 mm extra delicate	7 in	52142-56
curved, 32 mm extra delicate	7 in	52142-57
curved, 32 mm extra delicate	6 in	52142-59

## Metzenbaum (Nelson)

BLADE	LENGTH	CAT. NO.
curved, 49 mm	9 in	52142-73

Products shown actual size

## Bone Rongeurs

**52160**  
**FRIEDMAN**



**52161-02**  
**Micro FRIEDMAN**

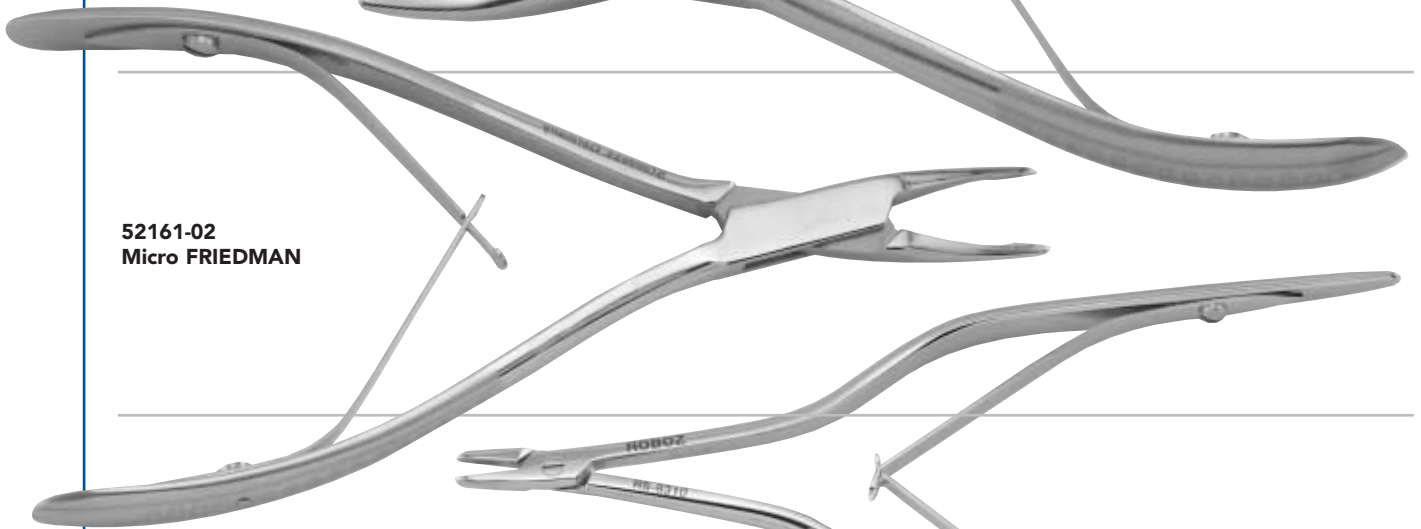

**52163**  
**Mini Bone Rongeur**

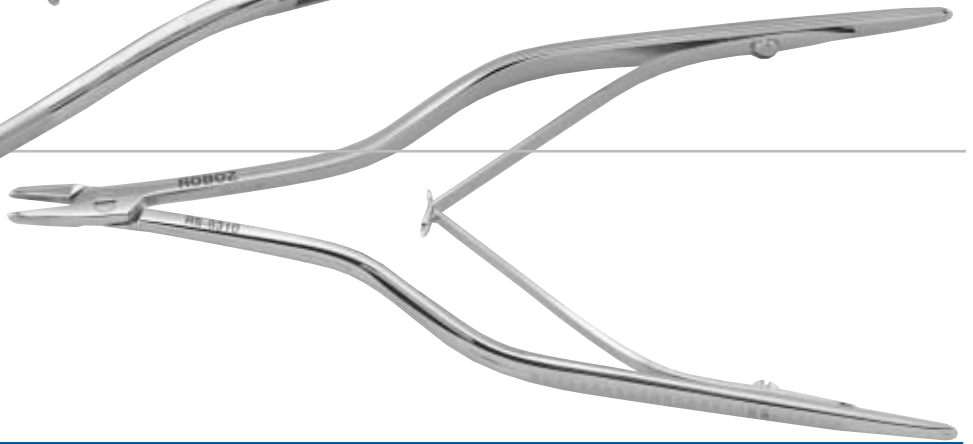

DESCRIPTION	JAW WIDTH	LENGTH	CAT. NO.	CAT. NO.	PRICE
FRIEDMAN, slight curve, delicate	2.0 mm	5.5 in	<b>52160</b>	<b>52160S</b>	<b>\$85.00</b>
Micro FRIEDMAN, straight	1.3 mm	5.5 in	<b>52161-02</b>		
Micro FRIEDMAN, curved	1.3 mm	5.5 in	<b>52161-03</b>		
Micro FRIEDMAN, slight curve, very delicate	1.0 mm	5.5 in	<b>52161-05</b>		
Mini Bone Rongeur	2.0 mm	5.0 in	<b>52163</b>		

Prices and Catalog Numbers for Stoelting Instruments are shown in magenta.

**52164**  
**Micro Blumenthal**



DESCRIPTION	JAW WIDTH	LENGTH	CAT. NO.	CAT. NO.	PRICE
Micro BLUMENTHAL, curved	2.0 mm	4.5 in	<b>52164</b>	<b>52164S</b>	<b>\$85.00</b>
BANE, curved	5.0 mm	7.0 in	<b>52165</b>		



# Bone Cutting Forceps

Products shown actual size



**52166**  
Bone Cutter



**52167-80**  
Littauer

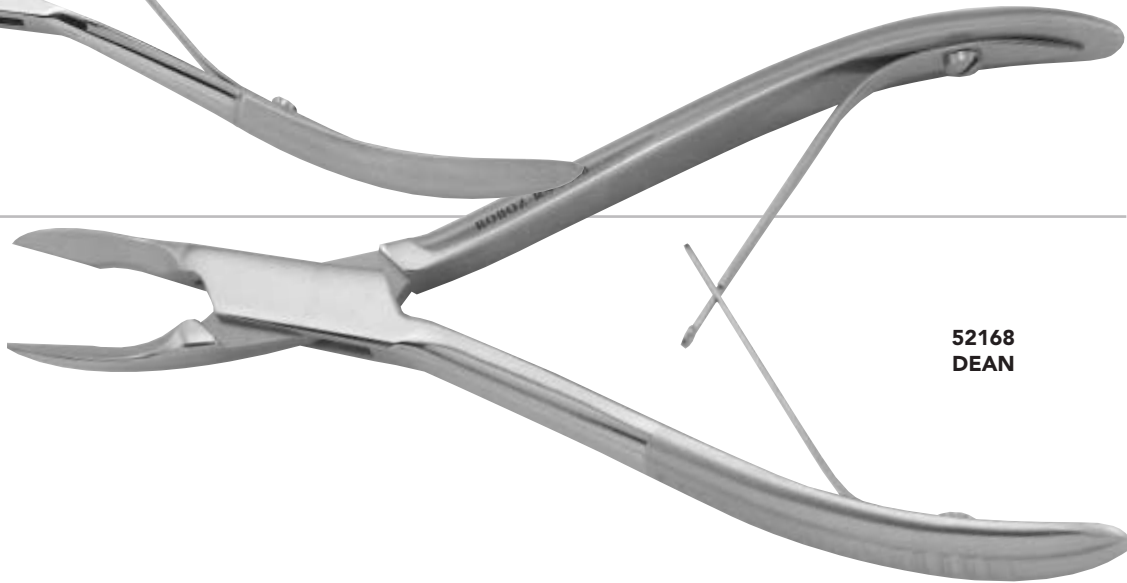

**52168**  
DEAN

Ideal for  
cranial  
dissections

DESCRIPTION	LENGTH	CAT. NO.
Bone cutter, convex jaws, delicate	5.0 in	<b>52166</b>
LITTAUER, straight	4.5 in	<b>52167-80</b>
LITTAUER, straight	5.0 in	<b>52167-82</b>
LITTAUER, straight	6.0 in	<b>52167-84</b>
DEAN, side-cutting	6.0 in	<b>52168</b>

# Bone Instruments

52169 FREER

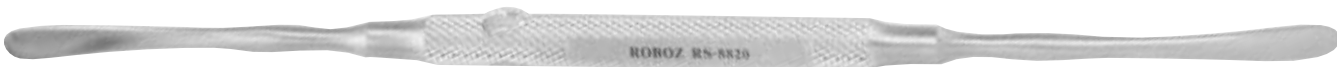

DESCRIPTION	LENGTH	CAT. NO.	CAT. NO.	PRICE
FREER Periosteal Elevator, Double-ended, sharp/blunt	7.0 in	<b>52169</b>	<b>52169S</b>	\$29.50
FREER Bone Chisel, width 4 mm	6.5 in	<b>52170</b>	<b>52170S</b>	\$29.50



See the new  
EZ Clip  
Wound  
Closing Kit on  
page 25

## Scalpel Blades

52173 Series

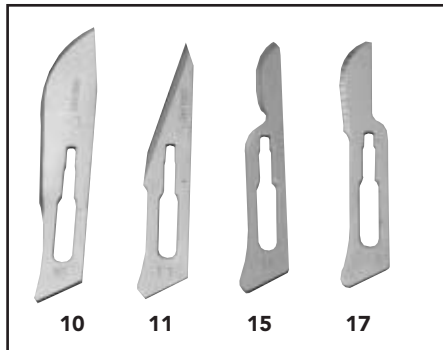

For use with Handle #3 or #7

DESCRIPTION	CAT. NO.
Scalpel blades #10, pkg of 12	<b>52173-10</b>
Scalpel blades #11, pkg of 12	<b>52173-11</b>
Scalpel blades #15, pkg of 12	<b>52173-15</b>
Scalpel blades #17, pkg of 12	<b>52173-17</b>

52175 Series

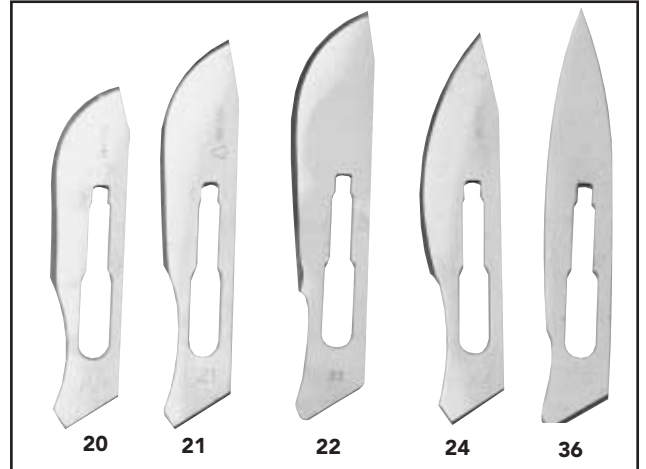

For use with Handle #4

DESCRIPTION	CAT. NO.
Scalpel blades #20, pkg of 12	<b>52175-20</b>
Scalpel blades #21, pkg of 12	<b>52175-21</b>
Scalpel blades #22, pkg of 12	<b>52175-22</b>
Scalpel blades #24, pkg of 12	<b>52175-24</b>
Scalpel blades #36, pkg of 12	<b>52175-36</b>

Prices  
and Catalog  
Numbers  
for Stoelting  
Instruments  
are shown  
in magenta.

Shown actual size

## Scalpel Handles

52171



52172



52174



DESCRIPTION	LENGTH	CAT. NO.	CAT. NO.	PRICE
Scalpel Handle #3	4.0 in	<b>52171</b>	<b>52171S</b>	\$7.50
Scalpel Handle #7	6.25 in	<b>52172</b>	<b>52172S</b>	\$10.50
Scalpel Handle #4	4.25 in	<b>52174</b>	<b>52174S</b>	\$7.00
Disposable Scalpel Blade Remover (Case of 50)		<b>52185</b>		

## Sterile Disposable Scalpels



Stainless steel surgical blades mounted on plastic handles with fluted finger-grips. Scalpel blade is safely protected by pull-off protector shield. Individually sealed in peel-apart, see-through package. Box of 10.

SIZE	CAT. NO.
Size 10	<b>52186</b>
Size 11	<b>52187</b>
Size 15	<b>52188</b>

## Needle Holders

Products shown actual size

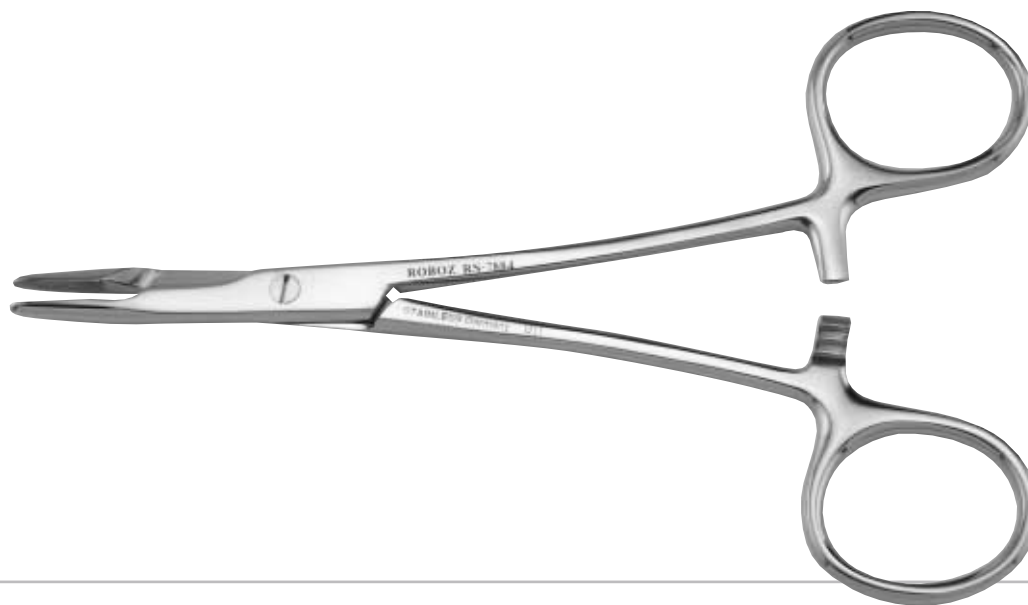

52181-84  
OLSEN-HEGAR

Firmly hold needles without damaging delicate tissue.

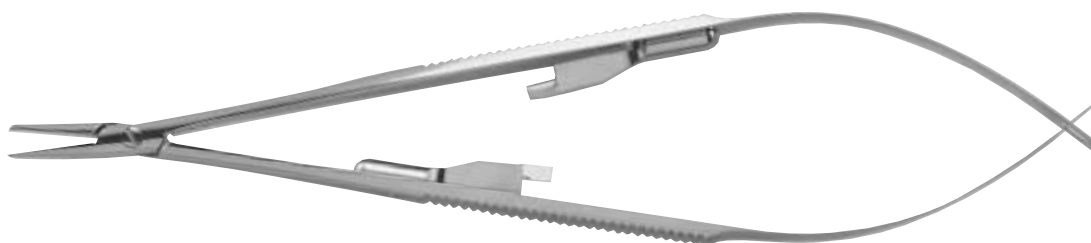

52182  
CASTROVIEJO

Needle does not rotate during surgery.

DESCRIPTION	JAWS	LENGTH	CAT. NO.	CAT. NO.	PRICE
OLSEN-HEGAR Needle Holder	serrated, extra delicate	4.75 in	52181-80		
OLSEN-HEGAR Needle Holder	extra delicate, smooth	4.75 in	52181-82		
OLSEN-HEGAR Needle Holder/Scissors	combination	5.5 in	52181-84		
OLSEN-HEGAR Needle Holder/Scissors	combination	6.5 in	52181-86		
OLSEN-HEGAR Needle Holder/Scissors	combination, carbide	4.75 in	52181-92		
OLSEN-HEGAR Needle Holder/Scissors	combination, carbide	5.5 in	52181-94		
OLSEN-HEGAR Needle Holder/Scissors	combination, carbide	6.5 in	52181-96		
CASTROVIEJO, Spring Needle Holder	straight with catch	5.75 in	52182	521825	\$95.00

## Dissecting Instruments & Ear Punch



52183  
WECKER

NAME	DESCRIPTION	LENGTH	CAT. NO.	CAT. NO.	PRICE
WECKER Micro Dissecting Spatula	Blade: 2 X 30 mm	5 in	52183	521835	\$39.00
Blunt Dissection Probe	One end semi-blunt, one end tapered and flat	6.25 in	52184		
Ear Punch	2 mm hole	4 in	56719		

# SURGICAL SUPPLIES



## Latex Examination Gloves

Natural rubber latex gloves shield user from pathogens or contamination. Rolled bead at wrist ensures easier donning and prevents roll down. Ambidextrous. Non-sterile. 100/box, 10 boxes/case.

Size	Box of 100	Case of 10 Boxes
Small (6-7) .....	<b>51000</b>	<b>51001</b>
Medium (7½-8) .....	<b>51002</b>	<b>51003</b>
Large (8½-9).....	<b>51004</b>	<b>51005</b>



## Powder-Free Latex Examination Gloves

Premium quality, powder-free comfortable hand protection. Rolled bead at wrist ensures easier donning and prevents roll down. New Micro-Rough texturing maximizes grip. Ambidextrous. Non-sterile.

Size	Box of 100	Case of 10 Boxes
Extra Small (5 - 6) .....	<b>51006</b>	<b>51007</b>
Small (6½ - 7) .....	<b>51008</b>	<b>51009</b>
Medium (7½ - 8) .....	<b>51010</b>	<b>51011</b>
Large (8½ - 9) .....	<b>51012</b>	<b>51013</b>



## Non-sterile Soft-Stretch Synthetic Examination Gloves

Latex-free. Lightly powdered or powder-free synthetic PVC. Beaded cuff. 9" length. Ambidextrous. Vinyl

Size	Box of 100	Case of 10 Boxes
Extra Small (5½ - 6) .....	<b>51014</b>	<b>51015</b>
Small (6½ - 7) .....	<b>51016</b>	<b>51017</b>
Medium (7½ - 8) .....	<b>51018</b>	<b>51019</b>
Large (8½ - 9) .....	<b>51020</b>	<b>51021</b>
Extra Large (9½ - 10).....	<b>51022</b>	<b>51023</b>

### Powder-Free Vinyl

Size	Box of 100	Case of 10 Boxes
Extra Small (5½ - 6) .....	<b>51024</b>	<b>51025</b>
Small (6½ - 7) .....	<b>51026</b>	<b>51027</b>
Medium (7½ - 8) .....	<b>51028</b>	<b>51029</b>
Large (8½ - 9) .....	<b>51030</b>	<b>51031</b>
Extra Large (9½ - 10).....	<b>51032</b>	<b>51033</b>



## Non-sterile Nitrile Powder-Free Examination Gloves

Popular alternative to latex gloves. Hypoallergenic. Powder-free. Micro-Rough texturing maximizes grip.

Size	Box of 100	Case of 10 Boxes
Small (6-7) .....	<b>51034</b>	<b>51035</b>
Medium (7½ - 8) .....	<b>51036</b>	<b>51037</b>
Large (8½ - 9) .....	<b>51038</b>	<b>51039</b>
Extra Large (9½ - 10).....	<b>51040</b>	<b>51041</b>

## A PLUS Aloe Coated Exam Gloves

New patented gloves are available with Aloe. New patented gloves have soothing aloe lotion coating on the inner surface, protecting hands from chafing and harsh environments. Latex and Nitrile. Non-Sterile.



<b>51055</b> Latex gloves with Aloe, small	<b>51063</b> Nitrile gloves with Aloe, small
<b>51056</b> Latex gloves with Aloe, small, case	<b>51064</b> Nitrile gloves with Aloe, small, case
<b>51057</b> Latex gloves with Aloe, medium	<b>51065</b> Nitrile gloves with Aloe, medium
<b>51058</b> Latex gloves with Aloe, medium, case	<b>51066</b> Nitrile gloves with Aloe, med., case
<b>51059</b> Latex gloves with Aloe, large	<b>51067</b> Nitrile gloves with Aloe, large
<b>51060</b> Latex gloves with Aloe, large, case	<b>51068</b> Nitrile gloves with Aloe, large, case
<b>51061</b> Latex gloves with Aloe, XL	<b>51069</b> Nitrile gloves with Aloe, XL
<b>51062</b> Latex gloves with Aloe, XL, case	<b>51070</b> Nitrile gloves with Aloe, XL, case

## Universal Size Exam Gloves

Quality hand protection. Will accommodate most hand sizes. Ambidextrous. Non-sterile.

- 51049** Unisize Latex gloves (6 - 8½), Box of 100
- 51050** Unisize Latex gloves (6 - 8½), Case of 20 boxes
- 51051** Unisize Powder-Free Latex gloves (6 - 8½), Box of 100
- 51052** Unisize Powder-Free Latex gloves (6 - 8½), Case of 20 boxes
- 51053** Unisize Synthetic gloves (6 - 8½), Box of 100
- 51054** Unisize Synthetic gloves (6 - 8½), Case of 10 boxes



## Sterile Surgical Gloves

This original white latex surgical glove offers uncompromising quality and durability. Beaded cuff reduces roll-down. Low latex allergens. Sterile. 50 pairs/box.

- 51042** Sterile surgical gloves, Size 6
- 51043** Sterile surgical gloves, Size 6½
- 51044** Sterile surgical gloves, Size 7
- 51045** Sterile surgical gloves, Size 7½
- 51046** Sterile surgical gloves, Size 8
- 51047** Sterile surgical gloves, Size 8½
- 51048** Sterile surgical gloves, Size 9



## Nurses' Bouffant Caps

Lightweight polypropylene fabric for comfort. Soft, non-irritating elastic band. Breathable, yet provides effective protection. Available in blue or white. Case of 500.

- 50951** Bouffant Caps, 24" blue
- 50952** Bouffant Caps, 24" white



## Earloop Face Masks

High filtration efficiency down to 0.6µ. Earloops of soft stretch yarn, three ply. Constructed with glass-free filter media inside soft non-irritating layers. Full-width flexible nosepiece for superior fit and security. Case of 300.

- 50953** Earloop face mask, blue
- 50954** Earloop face mask, yellow



## Tie-back Face Masks

Nonglass. High filtration efficiency down to 0.6µ. Hypoallergenic innerfacing. Anti-Fog.

- 50956** Tie-back mask, Blue, Foam backing, Box of 50
- 50957** Tie-back mask, Blue, Foam backing, Case of 300
- 50958** Tie-back mask, Green, No Foam Backing, Case of 300



## Cone Masks

Provides the wearer with 99% filtration efficiency at 1.0µ along with cool, breathable comfort. Elastic band holds mask in place and flexible nosepiece provides superior fit. Case of 300.

- 50955** Cone mask, blue



## Surgical Procedure Gowns

Lightweight 3-layer fabric provides contact isolation and protection from fluid contact. Elastic cuffs. Tie-back. Case of 100.

- 50982** Cover Gown, Yellow, Universal Size
- 50983** Cover Gown, Blue, Universal Size







## Shoe Covers

Non-conductive. Made of spunbonded polypropylene. Designed with heavy elastic around ankles for secure fit and complete coverage. Latex-free. 150 pairs/box.

**50959** Shoe cover, regular surface, unisize, blue



## Disposable Sterile Surgical Drapes

For use in minor surgical or therapeutic procedures where a sterile field or drape is required. Poly interlined, 3-ply construction of tissue/poly/tissue provides superior absorbency. Avoids possible moisture or bacteria migration. Available plain or fenestrated. Case of 300.

**50980** Surgical drape, fenestrated, 2-3/4" opening, 18" x 26"

**50981** Surgical drape, plain, 18" x 26"



## Sterilizing Pouches

Self-sealing. Compatible with steam, chemical vapor and EO Gas sterilizing processes. Box of 200.

**50985** Sterilizing pouches, 3.5" x 5.25"

**50986** Sterilizing pouches, 3.5" x 9"

**50987** Sterilizing pouches, 5.25" x 10"

**50988** Sterilizing pouches, 7.5" x 13"

**50989** Sterilizing pouches, 12" x 15"

## Steam & EO Gas Indicator Strips

Indicator strips that change color after sterilizing. 8" strips are designed for use with large packs or torn in half. 4" strips for smaller packs also available.

**50990** Steam indicator strips, Long, Box of 240

**50991** Steam indicator strips, Short, Box of 250

**50992** EO Gas indicator strips, Long, Box of 240

**50993** EO Gas indicator strips, Short, Box of 200

## NU Gauze™ Sterile & Non-Sterile General-Use Sponges

Unique rayon and polyester nonwoven fabric provides strength, absorbency and scrubbing texture. Sterile 2's have 2 sponges per envelope and 25 envelopes per box.

**50968** 2" x 2", 4-ply Sterile 2's, Case of 60 boxes (50/box)

**50969** 3" x 3", 4-ply Sterile 2's, Case of 48 boxes (50/box)

**50970** 4" x 4", 4-ply Sterile 2's, Case of 24 boxes (50/box)

**50971** 2" x 2", 4-ply, Case of 40 bags (200/bag)

**50972** 3" x 3", 4-ply, Case of 20 bags (200/bag)

**50973** 4" x 4", 4-ply, Case of 10 bags (200/bag)

## Non-Sterile Gauze Sponges

100% cotton. Long stable cotton yarn with selvaged edges folded inward to reduce linting.

**50960** 2" x 2", 8-ply, Case of 25 bags (200/bag)

**50961** 3" x 3", 12-ply, Case of 20 bags (200/bag)

**50962** 4" x 4", 8-ply, Case of 20 bags (200/bag)

**50963** 4" x 4", 12-ply, Case of 10 bags (200/bag)

## Sterile Gauze Pads

100% cotton. Peel-open package ensures sterile integrity and aseptic preparation. Edges are folded inward to eliminate linting and fraying. Sterile 2's have 2 sponges per envelope and 25 envelopes per box.

**50964** 4" x 4", 12-ply 2's, Case of 24 boxes (50/box)

**50965** 2" x 2", 8-ply 2's, Case of 30 boxes (50/box)

**50966** 3" x 3", 12-ply 1's, Case of 24 boxes (100/box)

**50967** 4" x 4", 8-ply 1's, Case of 12 boxes (100/box)



## Closed Circuit Gas Anesthesia Systems

**For Larger Animals—  
Dogs, Cats, Rabbits,  
and Guinea Pigs**

The closed circuit gas anesthesia system includes an absorption chamber for removing carbon dioxide from air exhaled into a mask. **This air can then be recycled back to a breathing bag for rebreathing, thus saving on the quantity of gas anesthetic agents, and medical air or oxygen needed.**

Excess pressure in the breathing bag is released through a pressure valve, which must be connected to an exhaust from the room.

Animals weighing over 7 kg have sufficient tidal volume to successfully operate the check valves in a closed circuit system. Masks (p. 53) and Endotracheal tubes are



available for closed circuit systems. Any system capable of closed circuit operation can also be used in an open circuit configuration. Furnished complete with 5-legged stand illustrated. Wall mounted system is also available.

### Specifications

O <sub>2</sub> Flow Meter .....	0.2-4.0 LPM
N <sub>2</sub> O Flow Meter.....	Optional (50203)
O <sub>2</sub> Low Flow Option .....	1-1000 cc/min. (50205)
Absorber Volume .....	1500 cc
Circuit Configuration .....	Closed for animals >7kg, Open for <7 kg
Vapor Concentration .....	0.5-5%
Breathing Bag.....	2 liter
Flow Rate Compensation.....	Automatic
Temperature Compensation.....	Automatic

- 50200** Closed System, Halothane
- 50250** Closed System, Isoflurane
- 50280** Wall Mount, Closed, Halothane
- 50281** Wall Mount, Closed, Isoflurane
- 50205** Optional Low Flow Kit for Rodents
- 53684** 1/4" Tygon Tubing, 50 ft.

## Isoflurane/Halothane Scavenger



The Isoflurane/Halothane Scavenger allows continuous flow without exposing the researcher to escaped gases. It recaptures the gases by vacuum and draws them through a disposable Fluosorber filter canister, which effectively removes halothane and isoflurane (Hunter, Glen, and Butcher, *Laboratory Animals* 18: 42-44, 1984; call for a reprint). **Nitrous oxide is not removed.**

Anesthetic gas from a vaporizer is connected via tubing to the scavenger unit and passed to a mask over the animal's nostrils. Gases are removed from the mask and the immediate vicinity by vacuum in an outer mask.

The scavenger is supplied with two rodent masks. Other masks for guinea pigs, cats, and rabbits are sold separately and listed below. Disposable Fluosorber canisters will absorb 200 gms of isoflurane or halothane.

- 50206** Isoflurane/Halothane Scavenger (Fluosorber Canisters not included)
- 50207** Fluosorber Canisters, Package of 6
- 50240** Rat Mask
- 50241** Mask for Guinea Pigs, Marmosets, etc.
- 50242** Mask for Rabbits, Cats etc.
- 53684** 1/4" Tygon Tubing, 50 ft.

## Two Flowmeter (O<sub>2</sub> & CO<sub>2</sub>) Table Top Gas Anesthesia Instrument

### For Rodent Surgery Lab

This table-top instrument includes both Oxygen and Nitrous Oxide flow meters for 1-1000 cc/min flow rates, suitable for rodents. Using nitrous oxide mixed with the anesthetic gases allows smaller doses of either than would be required alone. Both flowmeters and a vaporizer are mounted on a base with a drawer for storage.

This instrument is for open circuit use only, and must be used with the animal under a hood or with a scavenger such as the 50206 scavenger described on the previous page.

### Specifications

O <sub>2</sub> Flow Meter.....	1-1000 cc/min
N <sub>2</sub> O Flow Meter.....	1-1000 cc/min
Circuit Configuration .....	Open
Vapor Concentration .....	0.5-5%
Flow Rate Compensation .....	Automatic
Temperature Compensation.....	Automatic
Dimensions .....	15 in X 15 in



Sits on benchtop for convenient rat and mouse surgery

- 50260** Table Top Open Halothane System
- 50261** Table Top Open Isoflurane System
- 50265** Optional Rebreathing Assembly
- 51610** Rat Gas Mask for Stereotaxic Instrument
- 53684** 1/4" Tygon Tubing, 50 ft.

## Open Circuit Gas Anesthesia Systems

Stoelting has configured an open circuit system (without absorption chamber or breathing bag) for scientists who work only with rodents and small animals. The tidal volumes of small (<7kg) animals do not allow for an absorption chamber and recycling. A slow flow of gas from the vaporizer output is released at the animal's nose.

**NEW!** A tabletop model that has the same specifications as its 5-legged stand counterpart is now available. It offers a smaller footprint (16" x 7.5") than competitive instruments, and a lower price.

This instrument must be used with the animal under a hood, or with a scavenger such as the 50206 Scavenger offered on the previous page. The open circuit systems include a lower volume flowmeter (1-1000 cc) that provides better resolution when working only at low flows suitable for rodents. A special mask for stereotaxic surgery (51610) is available. 50201 and 50251 are furnished complete with 5-legged, wheeled stand.

### Specifications

O <sub>2</sub> Flow Meter.....	1-1000 cc/min
Vapor Concentration .....	0.5-5%
Flow Rate Compensation .....	Automatic
Temperature Compensation.....	Automatic



For Rats and Mice

**NEW**  
Low Cost  
Tabletop  
Model

- Economy Tabletop System**
- 50262** Open Halothane Tabletop System
- 50263** Open Isoflurane Tabletop System
- 5-legged, wheeled stand System**
- 50201** Open Halothane System
- 50251** Open Isoflurane System
- 51610** Rat Gas Mask for Stereotaxic Instrument
- 50206** Isoflurane/Halothane Scavenger
- 50207** Fluosorber Canisters, pk 6
- 53684** 1/4" Tygon Tubing, 50 ft.



# GAS ANESTHESIA APPARATUS



## Gas Anesthesia Vaporizers

These precision vaporizers used on the Gas Anesthesia Systems ensure that the output concentration is not affected by flow rate, temperature variation, duration of use, liquid level, or back pressure fluctuation.

This is the most popular vaporizer in veterinary and research labs.

Adaptors and tubing must be ordered separately.

- 50210** Halothane Vaporizer
- 50211** Isoflurane Vaporizer
- 50212** Tubing Inlet Adaptor
- 50213** Tubing Outlet Adaptor
- 50214** Rubber Tubing, 6 ft



## Induction Chambers

For initial anesthetization of animals difficult to keep masked when awake. Route gas through chamber, then to mask or 50206 Scavenger.

Two sizes are available: Rat/Small Rodent, 25x13x13 cm, Cat/Rabbit, 40x20x28 cm.

- 50216** Induction Chamber, Rat/Small Rodent
- 50237** Induction Chamber, Cat/Rabbit.



## Nitrous Oxide Kit

This add-on kit allows small amounts of Nitrous Oxide ( $N_2O$ ) to be mixed with the  $O_2$ .  **$N_2O$  dilutes the oxygen and reduces oxidative damage to tissues.**

The kit consists of a flowmeter (0.2-4.0 LPM), a safety valve, hoses, and tubing with a "Y" connector to join the  $O_2$  and  $N_2O$  flows.

- 50203** Nitrous Oxide Kit .2-4 LPM



## Yokes

Yokes add onto the Gas Anesthesia Systems for easy mobility. Yokes allow mounting the gas cylinders (E or D sizes) directly on the wheeled stand of the Gas Anesthesia System. Yokes come with single stage regulators, gauges and all needed hoses.

For 4 legged stand (older models)

- 50219** Yoke for 1  $O_2$ , 1  $N_2O$

For 5 legged stand

(Nos. 50200, 50201, 50250 and 50251)

- 50256** Yoke for 2  $O_2$  Tanks
- 50257** Yoke for  $O_2$  &  $N_2O$  Tanks
- 50258** Yoke for 2  $O_2$  & 2  $N_2O$  Tanks



## Large Tank Regulators

Large tanks require pressure regulators. These are two stage regulators, which step the pressure down to near the correct level, then precisely to the right level, with gauges for both the tank pressure and the end pressure. Supplied without hoses.

- 50217** Regulator,  $O_2$
- 50221** Regulator,  $N_2O$

### HOSES, FEMALE DISS TO FEMALE DISS CONNECTORS

- 50222**  $O_2$  Hose, 6'
- 50223**  $N_2O$  Hose, 6'

### HOSES, FEMALE DISS TO OHIO MALE QUICK CONNECTORS

- 50244**  $O_2$  Hose, 6'
- 50245**  $N_2O$  Hose, 6'



## Euthanasia Chamber

This product is perfect for rodents and other small animal species. The animal is placed inside the container and a cartridge is activated, thereby sending carbon dioxide into the chamber.

A flow limiting orifice and noise muffler are incorporated into the system preventing distress in the animals.

The specimen container is made of durable plastic and can be easily cleaned and/or replaced.

The system includes the container, valve assembly lid, and 3 carbon dioxide cartridges.

Size: approximately 8" tall x 6" wide.

- 51370** Small Animal Euthanasia Chamber
- 51369**  $CO_2$  Refill Cartridges, pkg of 10
- 51368** Replacement Container & Lid

## Rodent Gas Anesthesia Masks

### For Mice or Rats in a Stereotaxic Instrument

The Gas Mask for Stereotaxic instruments, manufactured by Stoelting, enables the scientist to use gas anesthesia on rats or mice on a Lab Standard™ or other brand of stereotaxic instrument, without personal exposure to the gas.

The Gas Anesthesia Mask is installed by removing the nose clamp and sliding the adaptor onto the incisor bar. The animal (rat or mouse) is installed by placing its teeth over the incisor bar, and sliding the adaptor forward until the cone is snug about the animal's nose. The teeth and the cone provide a snug, stable hold.

Anesthetic gas flows into the tubing connector on one side, through a chamber into which the animal's nose is inserted, and out the tubing connector on the other side. From there, it may be routed to recycling, exhaust, or gas analysis instruments.

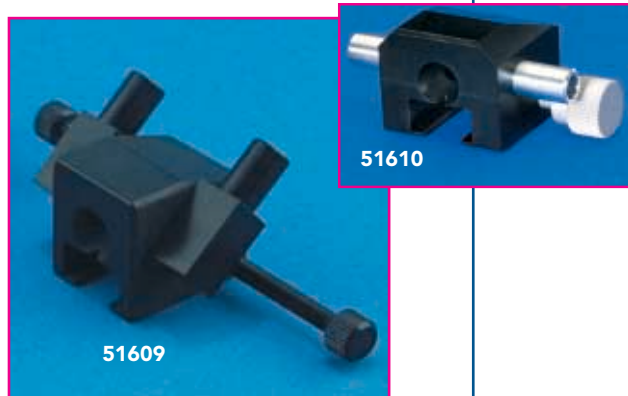

These gas masks fit the Lab Standard™ Stereotaxic Instrument 51600 (p. 2).

- 51610** Gas Anesthesia Mask, Rats
- 51609** Gas Anesthesia Mask, Mice

## Gas Anesthesia Platform

The Gas Anesthesia Platform for Mice (No. 50264) allows for precise and secure positioning of an animal during anesthesia and surgery when used with Stoelting's Mouse and Neonatal Rat Adaptor (51625).

### New Mouse Gas Mask Design

Our new improved mouse gas mask, with gas inlet and outlet projecting back at a 45-degree angle, allows for easy connection to gas anesthesia and scavenger systems. It may also be used as a stand-alone platform for dorsal surgery.



May also be used as a stand-alone platform for dorsal surgery.

- 50264** Gas Anesthesia Platform for Mice

## Larger Animal Anesthesia Masks

Plastic anesthesia masks are available in a range of sizes to fit all canine or feline subjects. The masks feature a clear cone for full visualization and a highly flexible rubber diaphragm to provide a leak-free fit. Please specify size.



- 50225** [S,M or L] Feline Mask
- 50226** [S,M or L] Replacement Diaphragm for Feline Mask
- 50227-S** Canine Mask, Small
- 50227-L** Canine Mask, Large
- 50229** [S or L] Replacement Diaphragm for Canine Masks



See page 58  
for a New  
Low-Cost  
Non-Invasive  
BP Recorder.

## Animal Respirators

This "quality-first" line of animal respirators from Basile is in every detail superior to competitive instruments. Their unique design ensures accuracy, durability and quietness of operation unequalled by any other respirator.

**Respirators are available for mice, rats, cats, dogs and monkeys.**

### Digital Stroke Rate Display

The stroke rate is displayed on an LED readout. These ventilators are the most accurate and reliable available, due to feedback controlled motor speed.

**Models 57125 and 56125 can be paused at user selected points in the cycle.**

### Easily Adjustable Stroke Volume

The stroke volume is adjustable whether the respirator is on or off. For the most convenient and accurate stroke volume control available, the knob and scale remain stationary, even when the piston is in motion. Other advantages of this unique mechanism are the elimination of mechanical noise, reduced wear, and very low maintenance requirements.

### NEW! Mouse Respirator

The new, low cost Mouse Respirator is ideal for use with mice and is also suitable for small birds and perinatal rats. It features quiet operation, negligible R.F. broadcasting, and impeccable finishing.



#### 50094 NEW Mouse Respirator

The valve mechanism on all of these respirators features nearly zero dead space and superb durability with no leakage. Expired air may be channeled for analysis when used with anesthetic gases.

Cat and rat units are supplied with one of two easily interchangeable cylinder/piston assemblies that enable a broader range of stroke volumes. A 0.5-5 ml. cylinder is available for the mouse.

- 50095-1 Rodent Respirator w/1-10 ml cyl.
- 50095-2 Mouse Respirator, 0.5 to 5 ml cyl.
- 50095-3 Rodent Respirator w/3-30 ml cyl.
- 50195-5 Cat/Rabbit Respirator w/10-50 ml cyl.
- 50195-10 Cat/Rabbit Respirator w/20-100 ml cyl.
- 57125 Rat Respirator w/pause
- 56125 Cat Respirator w/pause
- 50295 Dog Respirator w/50-700 ml cyl.

#### Cylinder/Piston for Rodent Respirator

- 50096-2 0.5-5 ml Assembly
- 50096-1 1-10 ml Assembly
- 50096-3 3-30 ml Assembly
- 50096-4 0.1-1 ml Assembly

#### Cylinder/Piston for Cat Respirator

- 50196-5 10-50 ml Assembly
- 50196-10 20-100 ml Assembly

#### 50094 NEW Mouse Respirator

solid state transducer, and an analog pressure signal is available for external monitoring.

In the volume mode, tidal volume is set by adjusting the flow rate and inspiratory time controls. In the pressure mode, end-inspiratory pressure is set using a calibrated ten-turn dial. A single switch instantly selects volume or pressure cycled operation.

### Configuring for Mouse

Both Fixed Volume and Pressure/Volume respirators can be configured for use with mouse using the LOW FLOW option package, 50065. Install the low flow option package inline, at the tubing junction on the front panel. The flowmeter reduces flow appropriate for use with low tidal volumes (such as from 0.1 ml-30 ml).

- 50071 Fixed Volume Respirator w/pump
- 50076 Pressure/Volume Respirator w/pump
- 50070 Volume Ventilator
- 50075 Pressure/Volume Respirator
- 50065 Low Flow Option for 50071
- 50066 Low Flow Option for 50076

For complete specifications of all of our products, visit [www.stoeltingco.com/physio](http://www.stoeltingco.com/physio)

## MRI Compatible Respirator



- Non-magnetic pneumatic valves
- Dependable all-electronic ventilator
- Wide tidal volume and rate range
- Mice to Guinea pig size
- Safe with oxygen and anesthesia
- Direct readout of volume and rate

Stoelting is proud to introduce this newest generation of the pressure-fed small animal respirator that can be used during MRI imaging.

The MRI respirator is supplied with a sophisticated external, remote-controlled high speed pneumatic valve system. The control unit is separate from all non-metallic remote components, ensuring the safety in operation.

These respirators function on "flow-time"; i.e., inspiration flow is set and run for a known time, producing a known volume. **Requires a separate source of compressed air or helium for operation of the pneumatic valves (not included.)**

- 50067 MRI respirator



See **NEW** micropipette puller with touch screen control pad. Page 97.



# Pressure Fed Small Animal Respirator

*Electronic Ventilation Control, Built-in Air Pump*

The built-in air pump provides the source of inspired air. Quiet, high-speed solenoid valves built into the instrument control airflow to the animal. Ports are provided for the collection of expired air for any desired analysis.

### Precise Controls

All of the standard control parameters, (e.g., cycling rate, volume and inspiration time), can be precisely regulated. Respiratory rate is set on a ten-turn dial, and displayed on an LED digital display. A front-panel flowmeter with a needle valve controls inspiratory flowrate. Inspiratory time is controlled by a ten-turn dial, or through a parallel port.

### Features

These Pressure Fed Small Animal Respirators include:

- 1) An analog output voltage proportional to respiratory rate
- 2) A digital logic output corresponding to respiratory phase (enables synchronizing other instruments to the animal's ventilation)
- 3) A manual inflation button to force sighs
- 4) A toggle switch to temporarily suspend inspiration

### Dual Mode Model – Pressure Or Volume

For animals in imperfect respiratory health, controlling the end-pressure reached by inspiration can be safer than controlling the volume to be inspired during a time period. Pressure/Volume Model (50076) allows this option. Airway pressure is continuously monitored by a





## CO<sub>2</sub> Monitor

*For Analysis of CO<sub>2</sub> Content of Exhaled Air*

The CO<sub>2</sub> content of exhaled air provides a measure of whether an animal on a respirator is getting adequate tidal volume and breath rate. The percentage of CO<sub>2</sub> in air exhaled into a mask can also be monitored with freely breathing animals under anesthesia to detect if the level of anesthesia is dangerously deep.

### Suitable For Rats or Mice

It provides continuous accurate measurement of CO<sub>2</sub> over the range of 0-10% CO<sub>2</sub>. The rapid response time and moderate sample flow requirements make this

instrument suitable for use with any size animal. Halothane and Isoflurane do not affect the signal, making these instruments appropriate for use with any of the gas anesthesia instruments and respirators in this catalog.

### Choice of Displays

The instrument can be set to display CO<sub>2</sub> concentration in percent, or in mm Hg. The displayed value can be the maximum CO<sub>2</sub> concentration reached at the end of each breath, or the continuous, rapid response, value of CO<sub>2</sub> concentration.

The CO<sub>2</sub> Monitor comes complete with sample cell, the 50082 Accessory Package containing two moisture traps with male-female Luer-Loc connectors, one 5' sample line with male connectors, and one 2' sample line with Nafion® tubing (absorbs condensed moisture).

See "Biologic Function and BP Monitors" on our website for complete specifications.

- 50080 CO<sub>2</sub> Monitor
- 50081 Moisture Traps
- 50082 Accessory Package
- 50083 Hydrophobic Filter, pk of 5

See pages 71 and 72 for the New Gas Metabolism Cage

## Metabolic Monitor For O<sub>2</sub> and CO<sub>2</sub>

The 50090 Metabolic Monitor measures oxygen consumption (VO<sub>2</sub>) and CO<sub>2</sub> production (VCO<sub>2</sub>). This system is suitable for comparing the metabolic rates of various strains of mice, and to detect group or individual differences in the metabolic response to stressors.

### High Technology Sensors

The keys to the accurate and sensitive measurements are the sensors. The flow is monitored by a solid-state thermal mass flow meter. A high-resolution paramagnetic O<sub>2</sub> sensor measures oxygen. Carbon dioxide level is measured with a special low-range infrared analyzer cell. The system microprocessor automatically calibrates the sensors against the ambient air inflow. Comparisons to room air are thus kept accurate even if some sensor drift has occurred.

Both basic and computed measures are displayed on the LCD panel. Basic measures are flow, O<sub>2</sub>, and CO<sub>2</sub> levels. Derived measures include VCO<sub>2</sub>, VO<sub>2</sub>, and the Respiratory Exchange Ratio (RER), or VCO<sub>2</sub>/VO<sub>2</sub>. The 3 basic measures are also presented as analog outputs that may be connected to any computer A/D collection system.



The 50090 O<sub>2</sub>/CO<sub>2</sub> monitor comes complete with a reusable one liter chamber, and necessary hoses. Expansion units are available as accessories to the 50090, and these multiplex units enable sampling from 4, 8, or 16 animal chambers. One liter (mouse size) chambers are standard; larger chambers for rats may also be used. The Metabolic Monitor automatically senses and controls the multiplex expansion unit, switching and sampling sequentially from attached animal chambers.

See "Biologic Function and BP Monitors" on our website for complete specifications.

- 50090 MM-100 Metabolic Gas Monitor
- 50091 Four Mouse Chamber Multiplex Unit
- 50092 Eight Mouse Chamber Multiplex Unit
- 50093 Sixteen Mouse Chamber Multiplex Unit
- 50086 Drierite Tube, pack of 4
- 50087 Dessicant Column, 6.7 x 29 cm
- 50060 External Air Pump, 0-4 lpm
- 50061 External Air Pump, 0-8 lpm
- 50062 External Air Pump, 0-16 lpm

Software Included



## Direct Blood Pressure Monitors With Heart Rate

### For Use With Catheterized or Cannulated Vessels

These highly accurate monitors are used with implanted catheters and a transducer to monitor blood pressure directly. They can be used to present a digital display of blood pressure (mean, diastolic, or systolic) or heart rate; or as a front end signal conditioner for data acquisition. Any full or half bridge pressure transducer can be used as the input. Our 56360 Pressure Transducer, listed below and on page 20, is suitable. A four-position selector switch allows the researcher to choose which of the derived values (mean pressure, diastolic pressure, systolic pressure, or heart rate) is to be displayed.

### Easy Calibration

A simple pressure calibration procedure is provided to calibrate the monitor for any full or half bridge pressure transducer.

50115



An automatic heart-rate tracking circuit is included, there is no requirement for the researcher to set or reset thresholds.

### Digital Display of Systolic, Diastolic, and Mean Pressure, Plus Heart Rate

Five analog outputs (BNC connectors) are provided: one each for mean, diastolic and systolic blood pressure, one for heart rate and one for the pulse wave form. Single and dual channel models. The dual channel model can be rack mounted.

- 50110** Single Channel Direct Blood Pressure Monitor
- 50115** Dual Channel Direct Blood Pressure Monitor
- 56360** Pressure Transducer, not included

## Non-Invasive Blood Pressure Transducer

The Patented Buffington Cuff, available only from Stoelting, is a non-invasive, calibratable blood pressure/blood volume transducer for rodents. It consists of two cuffs; a standard occlusion cuff and a patented, inflatable transducer cuff.

The inflatable transducer cuff presses sensitive piezoelectric sensors against the animal's tail or paw, with a reproducible pressure of application. This allows continuous (non-intermittent) monitoring of absolute blood pressure. The resulting signal may be recorded on the PowerLab® (see page 18), or any two channel rectilinear recorder with an input for a transducer (not supplied—see 56360) and an input for an ECG level signal.

**PowerLab® System  
Required, page 18**



### Validity

A larger Buffington Cuff for use on humans has been registered with the FDA. The validity of the cuff has been confirmed in published studies (Pfeffer, Pfeffer & Frohlich, J. Lab, 1978). Competing technologies, e.g. photoelectric pulse sensors, have been refused registration with the FDA because they are not calibratable due to skin pigmentation, skin thickness, etc.

- 50101** Rat Cuff and Pulse Sensor
- 50102** Mouse Cuff and Pulse Sensor
- 56360** Pressure Transducer, not included

See page 60 for **NEW** Muromachi Blood Pressure Monitor. No preheating of animal required!

# BLOOD PRESSURE MONITOR



**NEW!**  
Low-cost  
Activity  
Monitor  
See page 75

## New Low Cost

# Blood Pressure Recorder

The Manual Inflation BP monitor is a basic non-invasive tail cuff system that allows testing of a single animal at a time.

### Unique Features

The system requires minimal warming of rats and mice. The rodents should be warmed to an ambient temperature of 30°C for rats and 32°C for mice. The cuff has a built-in photoelectric sensor and the amplifier has an artifact filter, which minimizes the breathing and movement artifacts, enabling the user to pick out the endpoints easily.

## FEATURES

- Test results are within 5 mm Hg of Cannulation
- Low heat method: rats 30°C and mice at 32 °C
- Useful for mice, rats, (adaptors also available for cats, dogs, rabbits, pigs and monkeys)
- Built-in artifact filter
- Photoelectric Sensor built into the cuff
- Determine Systolic and Heart rate manually; Mean and Diastolic may be computed post hoc

The output is analog. The instrument has separate outputs for single channel and dual channel (superimposed and split) recording. The typical pulse amplitude is 100 mV to 1 V. The pressure amplitude is adjustable from 1 to 5 volts at 300 mm Hg. If systolic and heart rate are desired, a single channel chart recorder (No. 58805) is sufficient. If the Mean and Diastolic are the desired reading then a dual channel chart recorder is recommended (No. 58806) or the Chart Recorder software package (No. 58801).

### Linear Deflation Kit

We strongly recommend using the Linear Deflation Kit with this system. It is unique in that the valve allows the user to deflate the cuff at a constant rate. The rate is adjustable by means of the control screw in the valve head using the supplied screwdriver.

The valve's construction is made so that upon stopping inflation the deflation starts immediately at the set rate.

The Linear Deflation Kit consists of: A manual bulb with special valve, one air ballast, T connectors and one screwdriver.

### Chart Recorders

This single channel and dual channel recorders are ideal instruments for use in recording non-invasive blood pressure in laboratory animals. Chart Recorder Software converts BP outputs to digital data and replaces chart recorders.

The "Plot" and "Home" function can set the pen back to the start for comparative measurements. The pen starts from exactly the same point of the chart in a repetitive form.

### Included Accessories

The Manual Inflation BP monitor system comes complete with an amplifier, single channel chart recorder, a tail cuff and sensor to accommodate 150-380g rats, restrainer, cables, sphygmomanometer and accessory package. We strongly recommend using the Linear Deflation Kit with this system.

<b>58800</b>	Manual bp + chart recorder
<b>58803</b>	Linear Deflation Kit
<b>58805</b>	Single Channel Chart Recorder
<b>58806</b>	Dual Channel Chart Recorder
<b>58810</b>	Cuff and Sensor for Mouse, 25-80g
<b>58811</b>	Cuff and Sensor for Rat 70-160g
<b>58812</b>	Cuff and Sensor for Rat 150-380
<b>58813</b>	Cuff and Sensor for Rat 500-650g
<b>58801</b>	Software for Computer Interface

**See page 66 for appropriate Restrainers**



# Basile Non-Invasive Blood Pressure Recorder

*For Mice and Rats*

## Features

- Superior Pulse-Detecting Piezo Transducer
- USB compatibility
- Graphic printer
- Graphic LED display
- Reliable pressure for a smooth (stepless) pressure build-up
- Microcontrolled capability to store up to 3000 trials
- Analog and digital recording of all phases of the experiment

The 50050 Blood Pressure Recorder provides a non-invasive, objective and precise recording of the systolic and diastolic blood pressure.

## Proven Operation For Precise Measurements

The pulse transducer is composed of piezoceramic rings and fits the tail of the animal. It is then "stressed" by the rhythmical expansion caused by the systolic waves.

It is known that the stress causes a piezoelectric element to generate a proportional voltage; this voltage is led to the amplifier by a miniature coaxial cable.

A geared motor transmits the forward motion to a piston/cylinder pressure generator. The pressure is transmitted to an expansion vessel, the measuring pressure gauge and the tail cuff.

## BLOOD PRESSURE MONITOR



### Revolutionary Pressure Cuffs

The pressure cuffs are of simple design: they combine a substantially built tubular element of nickel plated brass, a rubber membrane, and Tygon tubing with a Luer coupling for branching to the pneumatic connection.

As soon the cuff pressure exceeds the diastolic pressure and starts to narrow the tail artery, the amplitude of the recorder pulse wave gradually decreases until the artery is completely constricted (ischemic) and the graph becomes a straight line.

This point indicates on the paper grid, on which the actual pressure of the system is digitally printed in 10 mm Hg steps, the maximum internal pressure of the artery (systolic pressure).

At the end of the recording the operator can, via the reverse key, operate a second pressure measurement, with decreasing pressure. The systolic pressure is indicated, this time, by the return of the pulse tracing.

An expendable foam rubber ring reduces the mechanical shocks brought about by the tail movements and thus minimizes the spurious signals.

**The 50050 Blood Pressure Recorder is supplied complete with 8 mm Rat Pulse Pick-Up, 13 mm Pressure Cuff, and 50 mm Rat Holder.**

<b>50050</b>	BP Recorder
<b>50350</b>	Pulse Pick-Up for Rat, 7 mm
<b>50351</b>	Pulse Pick-Up for Rat, 8 mm
<b>50352</b>	Pulse Pick-Up for Rat, 9 mm
<b>50355</b>	Pressure Cuff for Rat, 13 mm
<b>50357</b>	Rat Holder, 40mm
<b>50358</b>	Rat Holder, 50 mm
<b>50359</b>	Rat Holder, 60 mm
<b>50360</b>	Rat Heater (supplied with 5 Rat Holders)

**New**  
**Mouse**  
**Ventilator**  
**See page 54**





## Muromachi BP Monitor for Mice and Rats

*Preheating of Animals Not Required*

The 50370 BP Monitor is perfect for measuring the effects of drugs on animals.

Provided the room temperature is at least 23° C, animals blood pressure can be measured without heating the animal. After photoplethysmographically measuring tail arterial blood pressure, pulses are stored in the computer memory and peak levels of the pulses are plotted on a display.

**New low-cost Tail Flick Analgesia Instrument  
See page 80**

### Easy Operation

**Operation is a snap.** First, restrain the animal in one of the included holders (mouse or rat) and place on the measuring stand. The tail will fit neatly into a separate compartment, allowing for attachment of the cuff-pulse sensor.

Then simply press the START key and HR (heart rate), BPs (systolic BP), Bpm (mean BP), and BPd (diastolic BP) are automatically measured.

A printout shows data immediately, and said data can be exported to a computer via a serial port.

Initially, BP is estimated by inflating the cuff at approximately 25 mm Hg/sec. During cuff deflation at about 4-5 mm Hg/sec, actual BPs is determined precisely. BPs is defined empirically as the point when the pulse reappears. Bpm is defined experimentally as the cuff pressure when pulse amplitude becomes largest.

### Accurate Data Analysis

Data are plotted with X- (cuff pressure) and Y- (pulse amplitude) axes for easy interpretation. Using this method, the operator decreases the risk of selecting artifacts, and BP measurement, made more objective compared to conventional digital display methods.

### Included Accessories

Includes built-in printer, 9" display, Measuring Stand, choice of Cuff-Pulse Sensor, choice of Animal Holder, and 5 rolls of Thermo Chart Paper. A high-speed thermal printer, integral to the instrument, is also included.

*For PC compatibility, Data Collection Software (50391) is necessary.*

**Prices are subject to change due to currency fluctuations. Please call for a quote.**

<b>50370</b>	Muromachi BP Monitor
<b>50378</b>	Cuff-Pulse Sensor for Rats, 150-270g
<b>50379</b>	Cuff-Pulse Sensor for Rats, 270-500g
<b>50376</b>	Cuff-Pulse Sensor for Mice, 20-50g
<b>50375</b>	Cuff-Pulse Sensor for Mice, 10-20g
<b>50386</b>	Rat Holder, 150-210g
<b>50387</b>	Rat Holder, 210-270g
<b>50388</b>	Rat Holder, 270-350g
<b>50389</b>	Rat Holder, 350-500g
<b>50380</b>	Mouse Holder, 10-20g
<b>50381</b>	Mouse Holder, 20-30g
<b>50382</b>	Mouse Holder, 30-40g
<b>50383</b>	Mouse Holder, 40-50g
<b>50391</b>	Data Collection Software for Windows

# Muromachi Microwave Fixation Systems

## *Immediate Deactivation of Brain Enzymes*

The 10 to 90 seconds required for complete freezing following decapitation into liquid nitrogen is sufficient for significant degradation, phosphorylation, or other changes to occur.

**Microwave fixation is the fastest and most effective known method of halting brain chemical activity. Several important brain chemicals, including acetylcholine, dopamine, DARRP, HVA, and c-AMP begin changing state rapidly at death.**

Microwave fixation, however, yields chemical levels like those in the living brain (Mani et al., Science, 2000). **Levels of enzyme-regulated neurotransmitters, and metabolic substances in the brain, are stopped at the levels that existed in the living animal, while brain size and structure remain virtually unchanged.**

### Patented Microwave Focus Applicators

Microwaves are channeled and focused by the wave guide which focuses the microwaves from above the head, rather than in front. The entire rat head is placed in a uniform microwave field. Movements of the head do not change the field strength or microwave distribution. **Thus, uniform fixation of the whole brain is achieved, without "over cooking" and damage to the hypothalamus.**

Muromachi's unique applicators provide protection to the researcher and also compensate for individual differences between animals, giving more reproducible results.

### Compact Mobile Cabinet

The Muromachi Microwave Fixation System is enclosed in one cabinet, mounted on 5" casters, with a single convenient control panel.

Holders are available for animals from 20 to 500 gms. **You must order appropriate applicators and holders suitable for your application.**



50047 shown

**Free DOMESTIC Installation  
and training**

### Two Models, 5 or 10 kW

Two systems are available, differing in maximum power output, 5 or 10 kilowatts. In the 5kW system, fixation time can be regulated in 0.1 second steps from 0.1 to 9.9 seconds. The 10 kilowatt system can be regulated in 0.01 second steps from 0.01 to 2.99 seconds.

Choice of power level and fixation time depends on the size of the animal and the speed of fixation desired. Please call Stoelting to discuss your application.

Both microwave fixation systems require three phase power (220 V) plus ground, and 3 liter per minute water flow. The 5 kW system requires 30 Amp electrical service and the 10 kW system requires 60 Amp electrical service.

See "Histology Equipment" on our website for complete specifications.

Prices are subject to change due to currency fluctuations. Please call for a quote.

<b>50047</b>	Microwave, 10kW
<b>50037</b>	Microwave, 5kW
<b>50038</b>	Applicator, Mouse
<b>50039</b>	Applicator, <250g
<b>50040</b>	Applicator, >250g
<b>50051</b>	Holder, 20-40 g
<b>50055</b>	Holder, 150-250 g
<b>50056</b>	Holder, 250-400 g
<b>50057</b>	Holder, 400-500 g

# Oscillating Microtome

## Protect Cell Walls and Intracellular Chemistry

### Gentle for Fresh and Living Tissue

The Oscillating Microtome is the gentlest way to slice living, fresh, or fixed tissue. Conventional microtomes yield sections with fractured cell walls caused by the required hardening procedures (freezing or embedding). As a result, intracellular contents can leak out during staining.

However, an Oscillating Microtome gently "saws" its way through the soft tissue. **This oscillating blade is the best way to cut slices of living tissue for brain slice chambers or organ baths.**

### Preserves Cell Chemistry

More labeled cells can be seen with higher density labeling of intracellular contents, if the tissue has been sectioned with an oscillating blade. The cell membranes remain intact, and the contents remain inside the cell.

### Thinnest Slices

The Oscillating Microtome can cut sections as thin as 10 microns from fixed tissue. The slice thickness may be preset on a digital thumb wheel in **10 micron** increments. The tissue steps up by button press or automatically upon blade retraction. Retraction can also trigger a new blade advance, for continuous cycling as the researcher removes the sections. The instrument can be operated in either automatic or manual mode.

Several tissue mounting options come with the instrument, including the normal (95 x 25 x 48 mm) media tray and pedestal, mounting blocks and vise holder. A larger media tray, 56772, (95 x 25 x 73 mm) is optional. The blade angle may be adjusted from 5° to 30°.

### Cooling Available

The model 56765 has a built-in Peltier thermoelectric cooling unit, and can hold the media at any temperature from 0°C to ambient. The temperature level is displayed on a 3 digit LED. The Peltier requires a slow flow of water

### Included Accessories

The Oscillating Microtome comes complete with 25 blades, various means of mounting tissue, a tilting sample vise, foot switch, lamp, magnifier, adhesive, dust cover, and a manual.



56765 Shown

### Optional Accessories

Optional items include glass knives and holders, and the 56778 accessory kit which includes a sable brush, Parafilm, 5 tubes of adhesive, Kimwipes, a set of tweezers (#5, #6, #7), Fontax, specimen forceps (4", 6"), sample/specimen bottle with cap (6), and five each of micro beakers (5 ml and 7.5 ml).

### Specifications

CE Mark:	.....	Yes
Slice Thickness:	.....	10-990 microns
Blade Height Range:	.....	35 mm
Blade Speed:	.....	60-4000 CPM
Oscillation Amplitude:	.....	1.2 mm
Blade Advance Range:	.....	31 mm
Specimen Volume:	.....	25 mm x 25 mm x 15 mm
Blade Angle Adjustment:	.....	5-30 deg.
Power:	.....	115/220, 50-60 Hz, selectable

<b>56760</b>	Oscillating Microtome
<b>56765</b>	Oscillating Microtome w/Built-in Peltier Cooler
<b>56766</b>	Blades, pkg 25
<b>56767</b>	Adhesive, pkg 5
<b>56768</b>	Alum. Blocks, pkg 3
<b>56769</b>	Light Bulb
<b>56770</b>	Tissue Pedestal
<b>56771</b>	Tissue Pedestal for Large Tray
<b>56772</b>	Large Media Tray
<b>56773</b>	Glass Knife Holder
<b>56774</b>	Glass Knife Strips, 30
<b>56778</b>	Accessory Kit
<b>56776</b>	Standard Tray w/Pedestal
<b>56758</b>	Sapphire Blade

**NEW!**  
Low-cost  
Plethysmometer  
See page 77



**Stoelting**  
SINCE 1886

# Integraslice Microtome

High Precision  
Oscillating Microtome

## FEATURES

- No Z-Axis deflection, even at extremes of speed and amplitude
- Two Models Available: Programmable & Manual
- Electronic control system
- Ceramic blade technology
- Temperature control
- Magnifying Glass included

Integraslice is designed to provide you with the highest quality slices from the most difficult tissue slicing applications.

Blade advance and reverse during sectioning is precise and steadfast. A feedback system allows constant cutting speed to be maintained through variations in tissue density. The blade returns for next slice at high speed to minimize total sectioning time.

## Major Benefits

- Minimum of induced trauma
- Maximum preservation of cell structure
- Conservation of biochemical state
- Reduced tissue damage

A precision mechanical system raises tissue for maximum accuracy of slice thickness. Increments of 1 micron height resolution are set by stepper motor control, and a viewing mirror at rear of tissue enables you to see the point of entry. Coarse vertical height can be adjusted at rate of 1mm per second. Tissue is automatically lowered and withdrawn during the reverse stroke so the blade is not drawn across the next slice.

## Manual Model

The Manual Model features a motorized speed advance controlled by a rotary dial knob. Amplitude of oscillation can be manually adjusted.

The amplitude is manually adjustable between 0.5mm to



1.5mm at a maximum oscillation speed of 80Hz. The manual advance offers the fingertip sensitivity of the rotary dial knob. The set speed advance gives repeatability and consistency.

## Programmable Model

The Programmable Model has programmable cutting profiles of Speed, Distance and Section thickness, and features include Dynamically Adjustable Speed and Amplitude.

**The speed of advance can be slowed through one area and increased through another, with a resolution of 10 microns per second.** By selecting "record mode" and going manually through the first slice, the instrument effectively learns the changes of speed and distance as the blade travels.

When the third parameter of section thickness is entered and the number of slices required is set, **the instrument will then faithfully reproduce the parameters that it recorded.** This frees the operator's hands enabling them to harvest the slices in the shortest possible time.

## Additional Programmable Model Features

- Speed of oscillation may be changed dynamically; i.e. while sectioning a slice
- Amplitude may also be adjusted while sectioning

**51290** Integraslice Microtome, Manual

**51295** Integraslice Microtome, Programmable

## Accessories

**51291** Stereomicroscope

**51292** Replacement Tissue Bath

**51293** Autoclavable Tissue Bath

**51294** High Power Tissue Bath

**51296** High Power Tissue Bath, Autoclavable

**51298** Stainless Steel Blades, Pk/50

**51299** Ceramic Blades, Pk/5

See page  
93 for  
Quixell™  
Cell Transfer  
System





## Sliding Microtome

### Sliding Microtome from Leica®

This is the second generation of the famous A/O sliding microtome, manufactured in the United States under the Leica® trademark.

### Improved Safety

Safety features include a knife guard covering the blade, blade inclination adjustment without loosening the blade, and a lock to freeze the blade in any position. Ergonomic

design provides better access to the tissue sections and the blade drive.

### Maintenance Free

The micrometer feed system and blade slides are totally enclosed to protect against tissue waste entering the moving parts. Surfaces exposed to tissue can be easily cleaned.

Several options for tissue mounting and two knives are available: mounts and knives are not included. *At least ONE OF EACH must be chosen at the time of ordering.*

**When ordering the Sliding Microtome, you must also order your preferred tissue mount system – the 51312 Cassette Clamp, the 51313 Dry Ice Stage, or one of the freezing stages (51306 or 51406, see below) – AND preferred knife (the 51315, 16 cm blade, or 51317, 22 cm blade).**

### Specifications

Max. Specimen Size:..... 80 x 60 mm  
 Section Thickness Range:..... 1-60µ  
 Total Specimen Feed Range: ..... 40 mm

- 51310** Sliding Microtome
- 51312** Cassette Clamp
- 51313** Dry Ice Tray & Hardware
- 51315** Knife, "C" Profile, 16 cm
- 51317** Knife, "C" Profile, 22 cm

See page 61 for Microwave Fixation Systems that provide immediate deactivation of brain enzymes.

## Freezing Stage for Microtome

These new temperature controlled freezing stages have been designed with many new technical features:

- microprocessor-controlled temperature control
- continuous display of set and run temperature
- temperature control from -40°C to ambient temperature
- new "quick-thaw" switch allows to quickly defrost frozen samples
- switch on back converts from 110 or 220V operation

Also, new safety features include an overtemperature alarm to alert of low coolant flow or overuse of the quick-thaw option. If microtome is not next to a sink, these new models can operate with a recirculating bath.

### Two sizes available

Microtome model must be specified at time of order so that proper mounting hardware will be supplied with the freezing stage.

- 51303** Freezing Stage for Microtome, 3 x 4 cm
- 51304** Freezing Stage for Microtome, 7.5 x 8 cm



Microtome not included

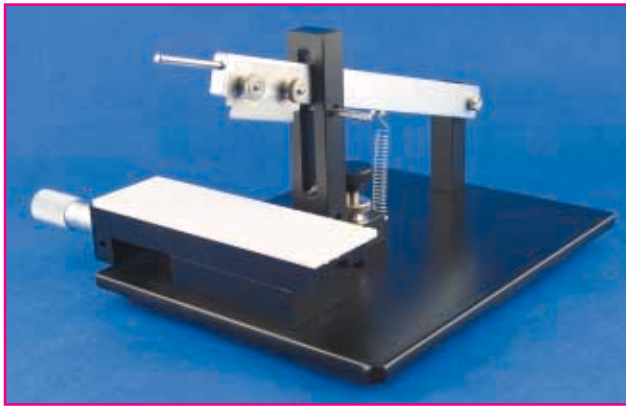

## Stoelting Tissue Slicer

### Fast Production of Living Tissue Slices

Originally designed to prepare thin slices of living brain, the tissue slicer is also excellent for slicing other tissues, in the blocking of fixed tissue for histology, and in the slicing of electrophoretic gels. Sections as thin as 150 microns can be reliably prepared.

The tissue cutting is done with a standard double-edged razor blade.

### Two Models

The 51425 Tissue Slicer has a conventional vernier micrometer, resolution 10 microns. The 51415 Digital Tissue Slicer has a digital display electronic micrometer, with 1 micron resolution. **Switch from mm to inches, set zero at any point, set low and high tolerance limits.** Features over-travel warning signal and output to a printer, processor, data logger or computer.

### Reversible Handedness

The tissue slicer can be reversed as to left or right handedness.

In use, the tissue is placed on the moistened filter paper and moved beneath the cutting edge. The cutting arm is lifted by its handle. The pin is removed and the arm is released, falling by its own weight (and assisted by the spring) thereby slicing through the tissue at high velocity. The cut tissue slice is removed from the razor blade with a small artist's brush moistened in incubation media. The cutting arm is lifted, the dovetail slide moved for the next slice, and the process repeated. Optional sapphire blades are sharper, will cut smoother, and stay sharp much longer.

- 51425** Tissue Slicer w/Millimeter Micrometer
- 51415** Tissue Slicer w/Digital Micrometer
- 51427** Metal Blades, pkg. of 5
- 56758** Sapphire Blade



## Mcllwain™ Tissue Chopper

### For Rapid Serial Sectioning of Multiple Preparations of Living Tissue

The Mcllwain™ Tissue Chopper is a proven instrument for rapidly sectioning living or fixed tissue without freezing or embedding to harden the tissue. It cuts living tissue into slices, cubes, arterial rings, etc. with a minimum of functional disturbance.

These preparations can be used in studies of metabolism or for electrophysiology. **The Mcllwain™ Tissue Chopper may also be used to cube fixed tissue for araldite embedding and EM.**

The specimen is affixed to filter paper or plastic discs (51354) and clipped to the instrument's stainless steel table top (cyanoacrylate adhesive may be used to hold tissue pieces in otherwise unstable positions.) The table moves at a pre-set speed. As it moves, a chopping arm is raised automatically, and chops down at frequencies from zero to 200 strokes per minute. **A pre-set stop prevents the attached blade from penetrating the filter paper and impacting the instrument's stainless steel table. In this way, serial sections of live tissue from 0-1 mm thickness may be cut rapidly.** The thickness is pre-set with a micrometer graduated in 1 micron and 25 micron increments. After sectioning in one plane, the instrument's table may be rotated any number of degrees, and the process repeated to obtain cubes or prisms.

Includes one pack of blades.

- 51350** Mcllwain™ Tissue Chopper
- 51352** Blades, pack of 10
- 51354** Plastic Discs, pack of 10
- 56767** Adhesive, pkg of 5

Save 70%  
on Surgical  
Instruments!  
See page 30

## Brain Punch Set



This set of 5 punches, with spring loaded nylon expellers, and a convenient handle, facilitates the "Palkovits Punch" technique of dissecting out specific brain nuclei for neurochemistry.

The nuclei are punched from frozen brain sections on glass slides, and expelled into the reagents. The spring-loaded expellers avoid risk of contamination that might be caused by expelling with breath.

Each punch has an electropolished sharp end for smooth cuts and minimal tissue adhesion. Punch sizes are 0.25, 0.50, 0.75, 1.0, and 1.25 ( $\pm 5\%$ , slight variation due to electropolish etching to sharpen). The smaller tubes are reinforced by an outer layer of concentric tubing except at the tip. Replacement punches available individually. Call for prices.

**57401** Brain Punch Set

## Intubation Needles

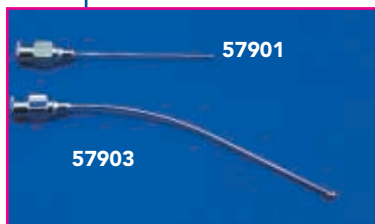

Designed for intubation feeding of lab animals. These needles are also ideal for transcardiac perfusions with fixative.

The ball end will not cut or puncture biological tubes, and can be conveniently tied in place. Sold in packages of 4.

- 57901** Needle, Straight, 22ga, 1-1/2"
- 57902** Needle, Straight, 18ga, 3"
- 57903** Needle, Curved, 18ga, 3"
- 57904** Needle, Straight, 14ga, 3"
- 57905** Needle, Straight, 13ga, 3"

## Mouse Restrainer, Head and Tail Access



These mouse restrainers are built in cylinder-shaped perspex. Lateral slots and holes allow for the animals ventilation and makes the access for i.p. drug administration possible. The available space for the animal can be adjusted by means of a sliding piston, thereby keeping the whole tail free for the pulse transducer and the cuff positioning or for i.v. drug administration.

The animal is led in from the back and can walk out in the front, thus avoiding dragging it backwards.

- 51324** Mouse Restrainer, H&T access to 50g
- 51325** Mouse Restrainer, H&T access to 35g
- 51326** Mouse Restrainer, H&T access to 25g



## Rabbit Restrainer

Provides total visibility of the animal and aids in retaining body warmth. The non-slip floor surface provides better footing and helps to calm the animal. A curved back/butt plate minimizes the possibility of a broken neck.

- 51328** Rabbit Restrainer, 0-4 Kg
- 51329** Rabbit Restrainer, 4-7 Kg



## Head Access Rodent Restrainer

Provides access to the head and also allows access to food and water if desired.

Offered in 4 sizes to accommodate indicated rodent weights.

- 51332** 15-30 Grams
- 51339** 30-125 Grams
- 51333** 125-250 Grams
- 51334** 250-425 Grams



## Tail Access Rodent Restrainer

The head is pushed back by the moveable disk so that the tail projects out the hole in the acrylic plate. Perfect for injections, blood sampling, or blood pressure monitoring.

- 51338** 15-30 Grams
- 51337** 30-125 Grams
- 51336** 125-250 Grams
- 51335** 250-500 Grams

## Decapitators

Stoelting's **small** animal decapitator has hardened and ground surgical stainless steel blades, aluminum base and stainless steel hardware. With its 1½" square maximum blade opening, it is suitable for decapitating rats, mice and other small animals. The decapitator cuts cleanly and quickly through bone and tissue. The base has four holes for bench mounting.

The **large** animal decapitator is similar to our small animal decapitator, but with maximum blade opening of 4 inches square. For use with rabbits, small monkeys, and other large sized animals.

Replacement blades are available only for the 51330.

- 51330** Small Animal Decapitator
- 51331** Large Animal Decapitator
- 51327** Replacement Blades for 51330, Factory Installed

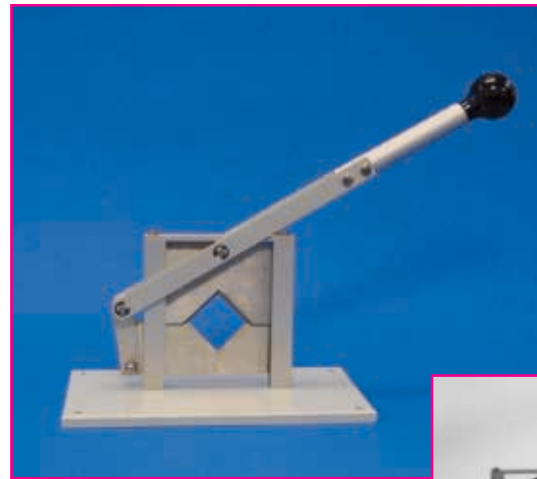

51330

## Cervical Dislocator

The Cervical Dislocator is a completely humane and efficient means of sacrificing laboratory rodents bloodlessly. Evidence indicates that the brain stem is terminated instantly by a blow from the metal bar.

There is no external wound, and so there is no blood to clean up, and no smell of blood to alert remaining animals. Pathogens or viruses are not spread. Blood and internal organs remain uncontaminated.

When used with the plastic restraint cones, the animal can be effectively and safely restrained during transfer between cages or through all necessary handling. The 5 cm opening is sufficient for most laboratory rodents. A 6 cm model is also available.

- 51360** Cervical Dislocator, 5 cm
- 51365** Cervical Dislocator, 6 cm



51360

## Rodent Restraint Cones

Disposable plastic restraint cones hold the animal safely in position for injections through the plastic bag, for decapitation, for cervical dislocation, or for examination of collected field specimens such as field mice or rats. The scientist avoids contact with feces or urine, and avoids bites and scratches.

The animal is easily loaded into the cone at the wide end, and heads for the breathing hole at the small end. Sold in packs of 50.

- 51361** Plastic Restraint Cones, pk 50



51361



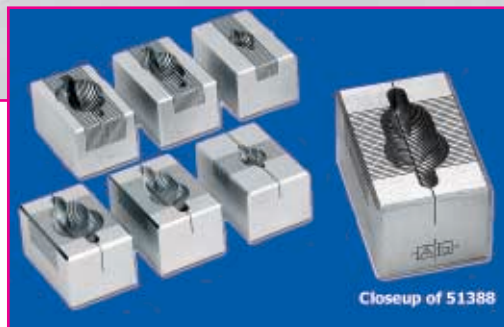

## Rodent Brain Matrices

Matrices are precisely machined and highly polished to ensure reproducible sectioning. Rat and mouse brain matrices are available. Coronal and sagittal sections at 1 mm intervals. All coronal brain matrices have an additional mid-line sagittal cut to aid in the separation of the left and right hemispheres. The mouse brain matrices can also be used on neonatal rat brains. Divisions are 1 mm apart.

Dimensions: H x L x W, 1 x 1.75 x 1.125 inches.

### Acrylic Brain Matrices

- 51380** Mouse, coronal
- 51381** Mouse, sagittal
- 51382** Small Rat (175-300g), coronal
- 51383** Small Rat (175-300g), sagittal
- 51384** Large Rat (300-600g), coronal
- 51385** Large Rat (300-600g), sagittal

### Stainless Steel Brain Matrices

- 51386** Mouse, coronal
- 51387** Mouse sagittal
- 51388** Small Rat, coronal
- 51389** Small Rat, sagittal
- 51390** Large Rat, coronal
- 51391** Large Rat, sagittal

### Single Edge Razor Blades

- 52176** Single Edge Razor Blades, box/100
- 52177** Single Edge Razor Blades, cs/1000
- 52178** Safety Pack Razor Blades, box/120

See pages 30-49 for more Surgical Instruments and Supplies.

## Sterile Disposable Scalpels



Stainless steel surgical blades mounted on plastic handles with fluted finger-grips. Scalpel blade is safely protected by pull-off protector shield. Individually sealed in peel-apart, see-through package. Box of 10.

SIZE	CAT. NO.
Size 10	<b>52186</b>
Size 11	<b>52187</b>
Size 15	<b>52188</b>



## Rodent Surgery Table

An attractive, durable table that is useful for surgery, perfusion, or autopsy on small animals. The top is 32x22 cm. and has slots to accommodate an assortment of accessories (included). The 1 cm thick styrene top is tough, non-heat absorbing, easily cleaned and may be tilted in any direction.

Stainless steel accessories are used to secure the animal to the table, retract tissue, etc.

Included are:

Vertical Rods (2) that install in the table slots and support bossheads that hold a horizontal rod; clamps that grip the rods or the table edge and anchor a chain; 15 cm lengths of chain with alligator clips (4); and 15 cm lengths of chain with 5 cm lengths of wire on the end (2).

The stainless steel wire may be bent to serve as retractors, leg clamps, incisor clamps, etc.

- 51375** Surgery Table w/Accessories

## Implantable Animal ID System



Electronic identification systems are more reliable and unalterable than traditional methods of animal marking such as ear punch, toe clips, or tail tattoo.

A small bioinert glass pellet roughly the size and shape of a grain of rice is implanted under the skin by simple injection involving no more trauma to the animal than ear punches or toe clips. This pellet encloses a passive electronic circuit (transponder with no battery or power source).

When the reader is passed near the chip, it powers the chip by induction, then reads the unique transmitted signal to identify the chip. Nothing in the chip is vulnerable to time passage or repeated usage.

### Hand Held Reader

This rugged, hand-held reader is ergonomically designed for comfortable operation and reading. The user's hand does not obscure the view or block the reader from getting close to the cage. It will read consistently at distances from 12 cm

to 35 cm. Pocket Reader (56722) works up to 7 cm and displays ID code, but does not store ID code.

The portable reader is offered as a stand alone model (56721) with belt hook that operates on standard alkaline batteries, or with an accessory kit including NiCad rechargeable batteries, recharger, serial port cable, Tag Manager® PC software, and 25 ID chips.

### Migration-Resistant Small Transponder

Early animal ID transponders, sealed only in glass, could tend to migrate under skin, and move from the original location. A thin bioinert coating of parylene becomes bonded to tissue very quickly and prevents migration of the transponder from the injection site. The transponders offered by Stoelting are the smallest commercially available transponders, and are suitable for use in labeling mice.

Each transponder comes enclosed in a single use needle, sterile and ready for injection. Chips are available in sets of 25 with an injector, or in sets of 10 without an injector.

### Convenient Injector

This system employs an easily held solid expeller device, to implant the transponder, and is included with every pack of 25 ID chips. Optional stainless steel injector (56726) available.

This system for animal identification gives hands-off, accurate, unique, and permanent ID to each individual specimen.

- 56720** Portable Reader w/Accessory Kit
- 56721** Portable Reader Only
- 56722** Pocket Reader, Read and Display only
- 56725** ID Chips/set of 25, with Injector
- 56726** Steel Injector
- 56727** ID Chips/set of 10, without Injector
- 56728** Carrying Case, Hardsided
- 56729** Carrying Case, Softsided

## Ear Punch Instruments

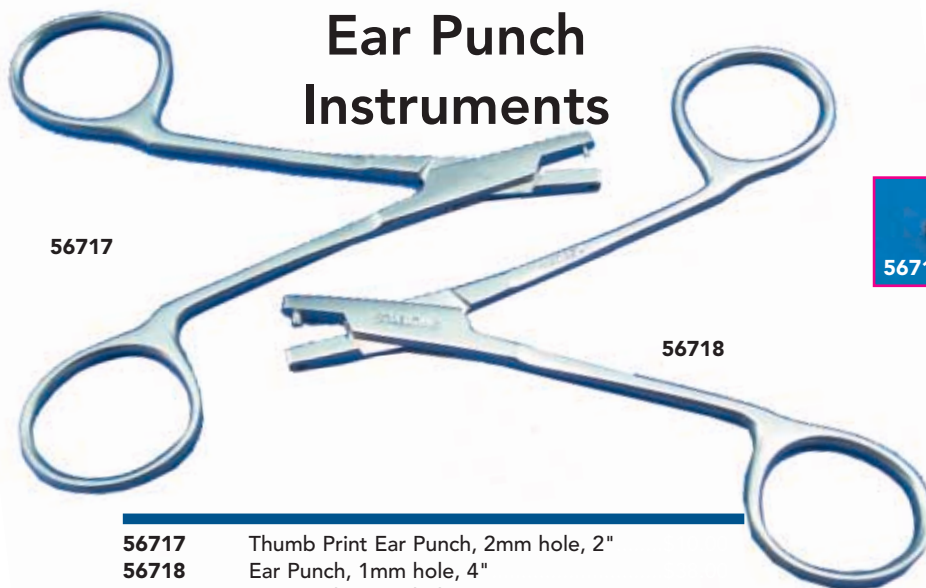

- 56717** Thumb Print Ear Punch, 2mm hole, 2"
- 56718** Ear Punch, 1mm hole, 4"
- 56719** Ear Punch, 2mm hole



# Activity and Metabolism Cages

All of our Activity and Metabolism Cages have been upgraded with the addition of load cells (miniature scales), which accurately read and record ingestion of food and water.

## THREE OPTIONS FOR HOUSING

- Classic Metabolism Cages
- Feeding and Drinking Analyzer Cages
- Gas Metabolism Cages

See page 79 for **New** low-cost Rotation Behavior System



**Classic Metabolism Cages** use the time-tested cylindrical metabolism cages for housing rats or mice. These familiar cages have been used for over 50 years, and are widely recognizable. There is one size available for mice, and three for rats. They are easily disassembled and may be cleaned and sanitized in standard vivarium facilities. The cages separate urine and feces into separate vials. (These cages are widely recognized as the best for use with rats. For mice, evaporative loss prevents accurate urine output for mouse.) A catch basin collects dropping food crumbs and another collects fluid spilled or leaked, thus minimizing lost volume.

**Feeding and Drinking Analyzer Cages** are custom built of Perspex (opaque acrylic), and have a box-like construction rather than rounded sides.

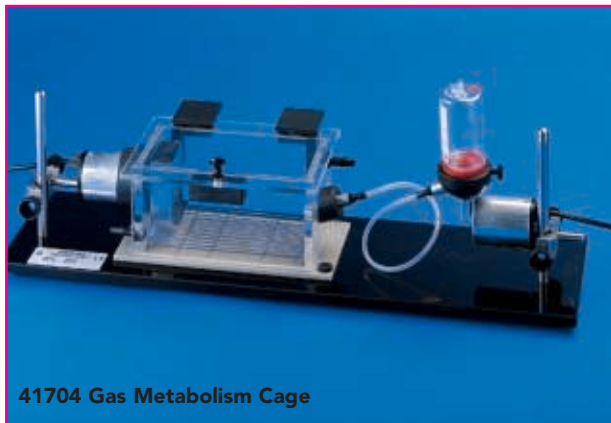

**Gas Metabolism Cages** are airtight, and have ports to allow monitoring of food and fluid intake as well as gas metabolism; (use with the 50090 Metabolic Monitor, p.56, to monitor a mouse's O<sub>2</sub> consumption, CO<sub>2</sub> production, VO<sub>2</sub>, and VCO<sub>2</sub>.) Infrared activity arrays may also be attached to monitor the animal's locomotion. The cage complies with the IACUC space requirements for mice.

## Features Common to All Cages

Animals may eat standard pellets, crushed, or powdered food. Crumbs are caught on trays to assure accurate recording of ingested food. The spigot for water is recessed into the cage wall to prevent accidental body contact and fluid loss; spilled fluid drops into a vessel for precise fluid measurements.

## Activity Monitoring

Infrared Activity arrays (emitters and detectors) can be added to any of these cages; these arrays record beam breaks as the animal moves about the cage (crossing an invisible beam triggers a digital pulse.) Horizontal movements are recorded in the X – Y plane; an identical array mounted higher on the activity monitor unit detects rearing behavior.

## Cages collect feces and urine

The durable Techniplast design metabolism cages are the foundation of these Basile animal cages. Basile Company has added sophisticated electronics and data collection to the famous design.

## Data Collection and Computer Requirements

These cages are not designed to be stand-alone; they require electronics units to power the load cells.

CMS Cage Monitoring Software is the suggested data acquisition system for these cages, but they can be configured for monitoring with Power Lab® (p. 18). A PCI card is also required and must be installed into the dedicated computer.

See complete information and specs online at [www.stoeltingco.com/physio](http://www.stoeltingco.com/physio)

<b>57460</b>	Metabolic Cage, mice
<b>57463</b>	Metabolic Cage, rats <150g
<b>57464</b>	Metabolic Cage, rats 150-300 g
<b>57465</b>	Metabolic Cage, rats >300g
<b>57452</b>	Feeding Analyzer Cage, rat
<b>57453</b>	Feeding Analyzer Cage, mouse
<b>57413</b>	Activity IR arrays for above cages
<b>41704</b>	Gas Metabolism Cage, mouse
<b>50090</b>	Metabolic Monitor (p. 56)

See page 18 for NEW PowerLab® Data Acquisition System...  
...Just turn it on and start recording.

# CMS Cage Monitoring Software

## Data acquisition from metabolism cages

The Basile CMS Software is custom configured for our Gas Metabolism, Feeding and Drinking, and/or Activity cages. CMS software uses the Labview® software platform which greatly enhances user interface, standardizes readings, data acquisition, and display.

The program can also be customized to specify the display module to be used for each channel, positions of the desired displays, icons on screen, etc. The software can be edited from the factory by Internet or direct dial connection.

The CMS software package is available in standard configurations for up to eight cages, or up to sixteen cages with feeding, drinking, or also with rearing activity.

Important details:

- CMS software requires (1) a dedicated computer, Win 98 or better, Pentium processor, with at least one expansion slot; (2) purchase of an appropriate electronic unit; and (3) purchase of PCI card to install in computer
- Electronic unit required to provide power to cage food and fluid monitor scales.

CMS software can be custom-configured for individual experiments. You can control the number of cages and parameters to be monitored.

<b>57479</b>	National Instruments Data Acquisition Card (PCI Card)
<b>52012</b>	CMS software, 8 cage configuration
<b>52013</b>	CMS software, 16 cage configuration
<b>52015</b>	Electronic unit, 8 cages, food & drink
<b>52016</b>	Electronic unit, 8 cages, food, drink and activity

Stoelting can provide a turnkey system, with software preloaded onto dedicated computer. Please call or write to discuss this option.

See page 96 for a New low-cost Pipette Puller



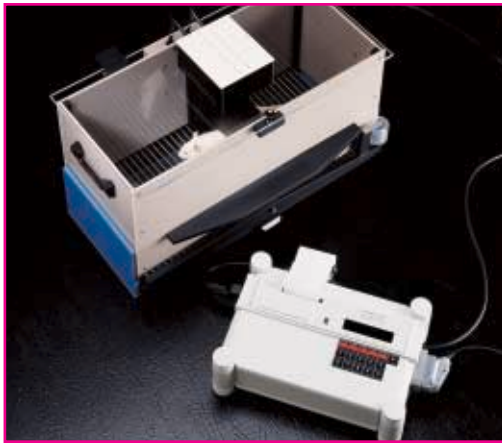

## Basile™ Shuttle Avoidance Instrument

### Unlimited Schedule Flexibility

The Shuttle Avoidance Instrument lets you specify any shuttle box schedule, including escape, learned helplessness, avoidance, multicrossing avoidance, or extinction, for any number of trials or timing parameters, including random.

### Flexible Stimulation Protocols

Lights and tones (for visual or acoustic cues) are provided, and may be used together or alone. When sound is used, the researcher may specify tone frequency (in Hz) and level (in dB). Scrambled shock generation is built-in and may be specified as during, after, or delayed-after the warning stimuli.

### Immediate Feedback

Data may be printed on the built-in thermal printer for immediate feedback in a selection of graphic and digital formats. A built-in clock keeps a record of date and time. A serial port port allows direct connection to a computer. **WIN DAS software is needed for computer data acquisition.**

---

<b>57530</b>	Shuttle Avoidance System, Rat
<b>57540</b>	Shuttle Avoidance System, Mice
<b>57534</b>	Switching Box for 2 Cages/Controller
<b>57532</b>	Extra Rat Cage
<b>57533</b>	Extra Mouse Cage
<b>52010</b>	WIN DAS Software



## Basile™ Passive Avoidance Apparatus

### For the Mouse, Rat and Cat

The Basile Passive Avoidance Instrument is an efficient,

reliable instrument for the classic passive avoidance task. **Rodents will normally crawl through a small opening into a darker chamber. If they are shocked in the dark chamber . . . this normal tendency is reduced, measured by longer latency or refusal to enter the dark chamber ...that is, to passively stay where they are.**

A unique elevator door design opens the passage to the dark side after a preset delay. The doors operate silently and automatically. Latency to pass through the doors is recorded with 0.1 sec. resolution. The controller allows digital setting of the shock intensity in milliamps.

### Data Collection

The Basile Passive Avoidance Instrument controller may be connected directly to the optional 52600, via RS-232C port communication. Computer interface requires WIN DAS software (52010).

---

<b>57550</b>	Passive Avoidance Instrument, Rat/Cat
<b>57553</b>	Passive Avoidance Instrument, Mouse
<b>52010</b>	WIN DAS Software
<b>52600</b>	Basile Computer Interface

## WIN DAS Software

WIN DAS software is a DOS-based software package that can accept incoming data from Ugo Basile instruments. The software is customized and configured with every order. At the time of ordering, please indicate the instrument that the WIN DAS will interface. Data from the

Plethysmometer (57140) and/or Hot Plate Analgesia Instrument (57280) can be ported (via RS232) directly to computer; all other Basile instruments require the Basile Computer Interface (52600).

---

<b>52010</b>	WIN DAS Software
<b>52600</b>	Basile Computer Interface

**New Low Cost**

# Stoelting Rota-Rod Treadmills

**Both Constant and Accelerating Speeds in One Treadmill**

The new Stoelting Rota-Rod provides an easy way to test the effects of drugs, brain damage, or diseases on motor coordination or fatigue resistance in rodents.

**Exclusive Features**

- 1 The Stoelting Rota-Rod can be quickly set to rotate at a constant speed or to gradually accelerate over a defined time (30 sec., 1, 2, 5 or 10 min).
- 2 Your Choice of the Stoelting Rota-Rod for Mice or Rats, or with an interchangeable drum for both Mice and Rats.
- 3 **No additional software is needed.** All data are stored in ASCII format for full exportability to other programs, and a built-in serial port allows the easy transfer of data to a PC.
- 4 The new Stoelting Rota-Rod is controlled by an advanced microprocessor, allowing for more precise timing control and ultra-accurate speed regulation.
- 5 The clear LCD panel on the front displays speed, acceleration, and individual lane timers. The resulting data are stored in memory.



For complete specifications and operation manuals, log on to [www.stoeltingco.com/physio](http://www.stoeltingco.com/physio)

The Stoelting Rota-Rod is very easy to use. Simply place the animal on the roller drum and start the timer. When the animal stops running, it drops safely into its own lane; time (minutes and seconds) and rotating speed are recorded automatically. A removable upper separator is included to prevent interference between animals running in adjacent lanes.

**Includes Data Collection Software.**

- 57610 Rota-Rod for mice
- 57615 Rota-Rod for rats
- 57620 Rota-Rod for mice or rats

## Basile Rota-Rod Treadmills



**Accelerating Speed Treadmill for Mice, Model 57650**

Treadmills are used to assess the effects of drugs, brain damage, or diseases on motor coordination or fatigue resistance. Both constant speed and accelerating units are available for the mouse and for the rat. Constant speed models work at fixed speeds; rat

model (57700) from 8-16 RPM, mouse model (57600) from 16-32 RPM. Accelerating rota-rods may be set at any speed from 2-40 RPM (speed increases at a linear rate.)

A central drum is divided into sections for individual animals (5 on the mouse unit as shown in the picture, 4 lanes on the rat unit.)

The drum surface is of knurled Perspex, which provides both a non-slip surface for the animal and easy cleaning. A 4 digit LCD timer counts in 1 sec. steps until the animal stops running and falls, which stops the clock.

These quality instruments are manufactured by Basile and must be connected to the Basile 52600 Computer Interface (p. 72) for automated data collection.

- 57600 Constant Speed Treadmill, Mice
- 57650 Accelerating Speed Treadmill, Mice
- 57700 Constant Speed Treadmill, Rats
- 57750 Accelerating Speed Treadmill, Rats
- 52600 Basile Computer Interface
- 52010 WIN DAS Software

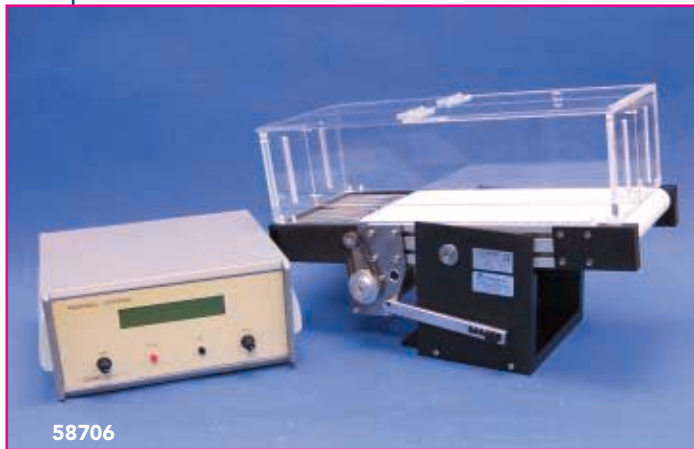

58706

## Stoelting Treadmill for Rodents

A flat treadmill, as used in human EKG stress testing, provides a better measure of fatigability than the "log rolling" of a Rota Rod, which is best used to measure motor coordination. The rodent has room to run and can correct errors in coordination before they result in failure.

The flat treadmill has a wide belt on rollers as a running surface. A built-in shock scrambler provides motivation for the animal to run until fatigued. The two lane

treadmill allows testing two animals at once. An acrylic cage with a divider between the lanes and a hinged lid encloses the animal. The single-lane treadmill has no divider between the lanes, and can accommodate larger animals. A six lane model for mice is also available.

### Multiple Controllable Parameters

The researcher sets the shock intensity and the belt speed, then adjusts the treadmill slope. The instrument records, for each lane, the total time spent on the shock grid. From the total time, the belt speed, and the time on the shock grid, the user can calculate the total distance the animal ran during the test. Software for PC control available (58704 below).

### Specifications

Current Range: ..... adjustable from 0 to 2 mA  
 Belt Speed: ..... adjustable from 0 to 0.6 m/sec.  
 Running Surface: ..... 450 mm long x 100 mm wide  
 Running Lanes: ... 2 or 1 depending upon model selected  
 Shock Grid: ..... 190 mm long x 100 mm wide  
 Slope: ..... adjustable from 0° to 25°

- 58700** Flat Treadmill, 1 Lane
- 58706** Flat Treadmill, 2 Lane
- 58703** Six Lane Treadmill for Mice
- 58704** Software for PC Control

**New**  
 high-precision  
 Microtome  
 See page 62

## Grip Strength Meter

### Measures the Force Required to Make a Mouse or a Rat Release its Grip

This instrument measures grip strength in mice or rats. The effects of drugs, toxins, muscle relaxants, disease, aging or neural damage on muscle strength may be assessed. The animal is placed on the plate and pulled across it by the tail. Rodents will instinctively grab anything they can to try to stop this involuntary backward movement, so they grip the adjustable trapeze bar until overcome by backward force.

The instrument freezes the peak pull-force achieved on its digital display. These data may then be recorded manually. There is also an analog signal output for automated data collection.

The electronic control units and transducers are calibrated for the best resolution for mouse or rat. Mouse model (57106) works from 1-100g, and rat model works over the range 10-1000g.

### Specifications

Range: ..... 100 g (mice), 1 kg (rats)  
 Resolution: ..... 0.1 g (mice), 1 g (rats)  
 Sensitivity: ..... 1  $\mu$ V/V/g (mice), 0.1  $\mu$ V/V/g (rats)  
 Dimension of plate: ..... 25 x 25 cm



Adjustable height: ..... 4-15 cm  
 Offset adjustable: ..... in any range 100%

- 57105** Grip Strength Meter for Rat
- 57106** Grip Strength Meter for Mouse
- 52010** WIN DAS Software
- 52600** Basile Computer Interface



# Hole Board Test

## Sensitive Test for Drug Effects on Exploratory Behavior in Mice

The normal mouse of either gender will explore holes in the substrate of its environment by plunging its head in and out of the hole a few times, then moving on to the next hole. This is a natural exploratory behavior, and very stereotypical of mice.

Various psychoactive drugs will influence the occurrence, persistence and duration of this behavior. A five-minute test, beginning immediately after setting the animal on the board, is sufficient for most screening or comparison purposes.

**Infrared emitter/detector arrays in each hole reliably detect head entry and removal. The circuitry distinguishes the rapid up-and-down movements of a single exploratory event, from separate exploratory events, interrupted by grooming, movement to a new hole, etc.**

Data are displayed as a raw number of beam breaks (head pokes). Connects to the 52600 Computer Interface (p. 72), for automated data collection into a Windows®



56650

computer. Computer Interface (52600) and WIN DAS software (52010) are both required.

- 56650** Hole Board Test
- 52010** WIN DAS Software
- 52600** Basile Computer Interface

# Stoelting Activity Monitor

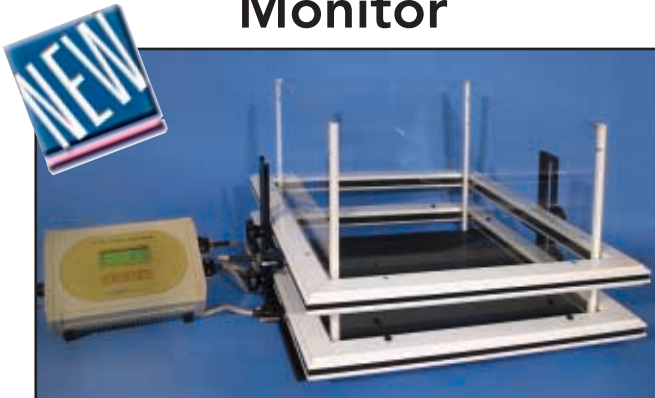

The Actimeter IR activity system is useful, flexible, and easy to operate open field test system. Trials may be performed with an animal in its home cage or in any clear enclosure. Two arrays of infrared emitters and detectors form a large 17 ft" by 17 ft" grid (with sensors 2.5 cm apart) quantify beam breaks, reporting these data:

- number of fast and slow movement (counts),
- total activity (counts)
- fast and slow movement events
- intervals of inactivity
- rearing behavior events and duration.

### Accurate Data

The firmware can discriminate between 2 and 100 beam breaks per minute for each IR emitter / detector, and it is

possible to set the discrimination threshold events counter to between 15 (min) and 1(max). Firmware also discriminates slow movements, fast movements, and stereotypical movements such as rocking or grooming. The upper IR frame may be used as a separate unit. Mounted on a separate support base, the upper IR frame may be used to examine locomotion in two separate fields, rather than examining locomotor activity plus rearing in one enclosure / field.

Trial duration minimum is ten seconds, maximum is 59 minutes, 59 seconds, and up to 200 trial intervals may be run sequentially. (Total maximum duration of an experiment approximately 8-1/2 days.)

**Data may be exported directly to a computer via serial port and free basic compilation software.**

Actitrack Software is a more comprehensive data acquisition and analysis package. It can discriminate and analyze frequency of IR beam breaks, total number of IR beam breaks, and assess periods of activity and sessile behavior.

- 58710** IR Activity System
- 58711** Transparent Acrylic Arena
- 58712** Four Quadrant Arena Divider
- 58713** Replacement IR Frames
- 58714** Replacement Field and Frame Support
- 58715** Head Poking Accessory
- 58717** Actitrack Software

Online quotations including all shipping charges available.

Visit our website for more information.





57140 Plethysmometer shown with 54210 optional stand

See page 18  
for the  
PowerLab  
Data  
Acquisition  
System...  
just turn it on  
and start  
recording.

## Plethysmometer (Paw Volume Meter)

The Basile™ Plethysmometer is a volume meter that has long been the standard instrument for measurement of rodent paw volume.

### Convenient, Accurate Measurement

The paw or object to be measured is inserted into water in a clear acrylic cell, up to a planned point, such as the wrist joint. The volume of water displaced is measured by a transducer. The specially designed transducer features automatic correction for changes in conductivity of the water due to contaminants introduced by successive measurements. **Thus, the measurements remain accurate and reliable even through a mass screening.**

### Programmable with Graphic Display

A large Graphic Display panel displays the current volume reading, the paw volume data, date, time of day (from the internal clock), animal weight, group, left or right paw, etc. The animal information can be entered as data is collected, or a preplanned sequence can be programmed into the instrument, and the instrument will then prompt the operator as to which measurement to take next.

All such programming is entered on function keys. The current function of each key is displayed on the lower line of the graphic display.

### Serial Port and Weighing Scale Port

The optional Ugo Basile Data Acquisition Software Package collects, manages, and stores the data from the Plethysmometer into a Windows based computer. There is also a port for connection to a printer and a serial port for direct connection to a computer, without purchasing any additional interface. Provision is also made for connection of several Plethysmometers to a single computer through the Basile 52600 Computer Interface.

The Plethysmometer comes complete with the electronics block, a foot switch, an 18 mm. water cell, a set of calibration volumes, a water reservoir, dust covers for the cells and electronics block, a bottle of wetting solution, and an operator's manual. An optional thermal printer is available. Stand not included.

### Specifications

Resolution: ..... 0.01 ml.  
Shipping Weight: ..... 7.0 Kg.  
Power ..... 110V or 120 VAC, 30 VA.

57140	Plethysmometer, Complete
52010	Data Acquisition Software for Windows
52600	Basile Computer Interface

### Optional Accessories

57156	Water Cell for Mice, 12 mm.
57152	Water Cell for Rats, 18 mm.
57157	Water Cell, Large, 25 mm.
57159	Water Cell, X-Large, 35 mm.
57153	Replacement Transducer, all cells
57154	Replacement Water Reservoir
54210	Stand for Water Cell and Reservoir
57145	Printer

### Consumables

57160	Wetting Compound
-------	------------------

## QUESTIONS?

Our Ph.D. Scientists will answer any product application questions you have.

Call (630) 860-9700  
or write to

[physiology@stoeltingco.com](mailto:physiology@stoeltingco.com).

***New Low Cost***

# Digital Plethysmometer

*For Measuring Paw Inflammation*

**This state-of-the-art Plethysmometer from Stoelting combines traditional quality with an exceptionally low price...it includes data collection software and computer interface**

The Digital Plethysmometer is an instrument designed to provide a useful tool in the measurement of small volume changes. **This is a test to screen potential anti-inflammatory or anti-edema agents, or to determine if a drug causes inflammation as a side effect.**

The volume transducer is formed by two Perspex tubes, which are interconnected and filled with a conductive solution.

The water displacement produced by the immersion of an object in the measuring tube induces a change in the conductance, as measured between two platinum electrodes in the second tube. The Plethysmometer's control unit measures these conductance changes, and generates an output signal, accurate to 0.01 mL.

**Software Included**

**NEW**



The electronic circuit provides great measuring stability and the device has a serial port for easy output to a PC.

All this is supported by a stand (included) that can be placed over the control unit.

**The 58730 Digital Plethysmometer comes complete with Control Unit, Volume Transducer, and FREE software for use with your PC.**

- 58730** Digital Plethysmometer complete with Data Collection Software
- 58731** 5 ml water cell for 50370
- 58732** 3 ml water cell for 50370
- 58733** 1 ml water cell for 50370
- 58734** Replacement electrode for 50370

Visit our website for online quotations and ordering.

# Incapacitance Analgesia Meter

**New Test for Measurement of Paw Pain Inflammation**

This new instrument is an alternative to the Paw Pressure Analgesia Meter (Randall-Selitto Test), with significant advantages (Bove, et al., 2003. Osteo Cart.). **It is a dual channel scale that separately measures the weight the animal distributes to each hind paw.** While normal rats distribute weight 50-50, the ratio of weight distribution between an injured and non-injured paw is a natural measure of the level of discomfort in the injured paw, and correlates with the Paw Pressure Analgesia Meter.

**The Incapacitance meter does not require restraint, and provides a value independent of researcher reaction time or subjective judgements about whether the animal has flinched or not.**



Also, it does not involve provoking a pained area to see latency of withdrawal. The animal stands and makes its natural adjustment to the degree of pain.

- 57210** Incapacitance Meter
- 57212** Mouse holder for 57210

## New Low Cost Stoelting Hot Plate

Software Included



## Analgesia Instrument

### Precise screening of analgesic drug effects

This new, low-cost Hot Plate Analgesia Instrument enables the assessment of the effect of analgesic drugs. This method evaluates the reaction time of mice which are confronted with a heat stimulus applied to the plantar surface.

The plate temperature can be controlled between 45° C and 62° C, in 0.1° C steps. A built-in timer (0.01 sec steps) activated by an external pedal allows for the precise measurement of the reaction time. The rodent is confined by a clear, removable Perspex cylinder.

A serial port and a data-communication software allows for the transfer of data to a computer. A Perspex cylinder is also included in the standard package.

**58725** Hot Plate Analgesia Instrument  
complete with Data Collection Software

## Basile Hot Plate Analgesia Instrument



This hot plate analgesia instrument allows direct connection to a computer via a serial port and WIN DAS software. The animal is dropped onto a hot surface as a foot pedal is pressed to start a clock. The observer presses the foot pedal again when the animal

makes a stereotyped paw lick response to the hot surface. This latency is strongly affected by analgesic drugs.

Temperature regulation and surface distribution is improved by a 4 mm thick copper plate, held at a setpoint between 30° and 60°C to an accuracy of +/- 0.1°C by multiple proportional feedback circuits that minimize overshoot. The animal's reaction time is recorded to 0.1 sec. Supplied with two chambers, for mice and rats.

The 57280 comes with foot pedal, a restraining cylinder for rats and one for mice, a manual, and a power cord.

**57280** Hot Plate Analgesia Instrument  
**57390** Heat-Flux Radiometer  
**52010** WIN DAS Software  
**52600** Basile Computer Interface

## Radiometer

### For Precise Calibration Of Infrared Analgesia Meters

Both the 57350 Tail Flick (p. 80) and the 57370 Plantar Analgesia Instruments (p. 81) emit focused infrared beams to provide a heat stimulus to a mouse or rat. The source of the infrared radiation is a commercial tungsten incandescent light bulb.

All bulbs share the property that, for a given electrical current, the amount of light emitted per unit time will

gradually decline over the life of the bulb, down to as low as 75% of starting emission.

Thus, although it is easy to calibrate an instrument for a specific current flow, this does not determine a specific infrared light stimulus intensity.

The Radiometer provides a measure of stimulus intensity in mW/cm<sup>2</sup>, and it allows for assuring that all Infrared instruments are emitting the same level of stimulus intensity.

Each Radiometer is shipped in an attractive plastic carrying case with adaptors for the Plantar and the Tail Flick, and a manual.

**57390** Heat-Flux Radiometer



**New Low Cost**

# Stoelting Paw Pressure Analgesia Instrument

The Paw Pressure Analgesia Instrument is for the Randall-Selitto test, which requires the application of increasing pressure on the paw between a flat surface and a blunt pointer. It is usually used with animals with one paw inflamed by an injection, and one normal paw, to evaluate drugs for analgesic action.

The device exerts steadily increasing force on the rat paw until the animal makes a stereotyped flinch response. **This increase is achieved by means of a stepper-motor, which produces a progressive advancement of a sliding support with a conic tip, thus increasing the pressure on the paw.**

It is controlled by a pedal which moves the tip down. A PC-compatible (via built-in serial port) control unit measures current tip pressure (in grams), and allows for



adjustment of both the force transducer and stepper-motor speed.

Data are recorded once the distal extreme of the support track is reached, or when the pedal is released at the test ending point. The pressure value reached in the trial is recorded and remains in the display until a new trial is started.

**58727** Paw Pressure Analgesy Meter complete with Data Collection Software

# Basile Paw Pressure Analgesia Instrument



**The paw pressure meter increases pressure via a mechanical thread drive.** The paw is positioned under a fulcrum, and force increases as the weight is moved a greater distance from the fulcrum (gravity-driven).

Pressing the foot pedal drives the motor, causing weight to advance and pressure to increase. When the animal withdraws its paw, the user lifts his foot off the pedal, and the force is calculated based upon the distance that the weight traveled.

This new design includes a removable foot pedal cord and a cable connection for computer data collection via the 52600 Computer Interface (p. 72).

**57215** Paw Pressure Analgesia Instrument  
**57206** Extra Disc Weight  
**52010** WIN DAS Software  
**52600** Basile Computer Interface

# Rotational Behavior Monitor

Monitoring rotational behavior is important in striatal lesion models and other behaviors. The sensitivity of signal can be adjusted from 24 - 360 pulses per turn with this device, reliably discriminating even partial turns. **Data are additive, providing a comprehensive assessment of turning behavior for both directions.**

Includes enclosure, support rod, rotational sensor, connecting wire, and electronic control unit with

integrated thermal printer. The electronic control unit included in the basic unit can accept data from up to three sensors and enclosures.

The optional Multicounter Control Unit can integrate data from up to 15 Rotational Behavior Monitors, and includes free data collection software.

**58760** Rotational Behavior Monitor System  
**58761** Additional Sensor and Enclosure  
**58765** Multicounter Control Unit with Free Data Collection Software



## New Low Cost

# Stoelting Tail Flick Analgesia Instrument

**For Fast, Sensitive Screening of Analgesic Effects**

The Stoelting Tail Flick Analgesy Meter is based on the measurement of the latency of the avoidance response when pain is induced by radiant heat applied to the animal's tail.

The animal is placed on a base and restrained. When the animal reacts against pain by a sudden tail movement (tail flick), the stimulation stops and the reaction time is measured by a digital clock. Response time is displayed and may be directly exported to a computer for statistical analysis via a serial port. Times are recorded to a 0.01 second accuracy.

The heat stimulus comes from a halogen lamp imbedded in the pivoting stand, and heat intensity can be adjusted from 40°C to 120°C in 10-degree increments (9 different settings).



**Included is a restrainer for 250 gram animals, and Windows-compatible software for easy data transfer to computer.**

**58726** Tail Flick Analgesy Meter complete with Data Collection Software



**57369**

# Basile Tail Flick Analgesia Instrument

Compare pain sensitivity accurately and reproducibly in mice or rats. The animal's tail is placed over a window on the platform while the animal is restrained in an acrylic holder or by hand.

A foot switch activates an intense light beam to the tail, adjustable in the range of 60°C - 170°C. When the level

of discomfort is reached, the animal will flick its tail out of the beam.

The time from activation of the light beam to animal response is displayed in large LED numbers with a resolution to 0.1 seconds. Since the onset of thermal stimulation and the animal's response are both detected electronically, the operator's reaction time is not a factor. May be used with the Basile Computer Interface (52600) and WIN DAS Software (52010).

**An optional Tilted Mouse Restrainer (57369) is essential to keep a mouse's tail on the emitter until stimulated.**

- 57350** Analgesia Instrument, Tail Flick
- 57364** Replacement Bulb, Plantar & 57350
- 57369** Tilted Mouse Restrainer
- 52600** Basile Computer Interface
- 57390** Heat-Flux Radiometer
- 52010** WIN DAS Software
- 52600** Basile Computer Interface

See page 92 for our  
Synaptosome Superfusion System

# Plantar™ Analgesia Instrument

## Measures Paw Sensitivity to Heat Stimulation

The Plantar™ Analgesia Instrument represents a remarkable advance in methodology for assessing pain sensitivity in laboratory animals. **Unique to the Plantar Analgesia Instrument, the animal is unrestrained and unhandled.** This avoids activating the adrenal system, which by itself can affect pain sensitivity and the speed of the animal's response to pain.

### Unrestrained

Animals move freely (not restrained) on an elevated glass surface. The researcher waits until the animal is at rest, then moves a fiber-optic heat source under the animal's feet, and triggers the infrared beam. The rising temperature on the bottom of the foot will cause the animal to move its foot. This changes the reflected light, which stops the timer. Latency to move the foot is recorded in an automatic (objective) manner.

### Major Advantages

Plantar Analgesia testing combines the best features of the other three methods of measuring pain sensitivity.

- 1) It allows *bilateral testing*, like the Randall-Selitto (paw pressure) method.
- 2) The behavioral end point is *detected automatically*, as with the Tail Flick method.
- 3) It stimulates the *glabrous normal skin* of the foot, as opposed to the unique tissue of the tail, as does the Hot Plate method.
- 4) *Repeated testing* does not result in sensitization, an advantage shared only with the Tail Flick method.

Since the animal is free to move and behave without restraint, other more subjective measures of behavior may also be recorded:

- Duration of the foot lift
- Velocity of the withdrawal reflex
- Associated behaviors such as licking of the paw (Hargreaves, 1988).

These measures, unavailable with any other method of analgesia testing, provide additional information about the effect of the drug and the state of the animal.



57370

With the Plantar Analgesia Instrument, the animal is unrestrained during experiments

### Complete System

The instrument comes complete with the sliding infrared source, a glass platform, a three compartment rat enclosure or a six compartment mouse enclosure, a controller, and a manual.

For data collection, WIN DAS Software (52100) and Basile Computer Interface (52600) are required. See page 72 for details.

<b>57370</b>	Plantar Test, Rat
<b>57379</b>	Plantar Test, Mice
<b>52010</b>	WIN DAS Software
<b>52600</b>	Basile Computer Interface
<b>57390</b>	Heat-Flux Radiometer

## SCIENTISTS/INVENTORS

We welcome your ideas.  
If you have developed  
an instrument, or have an idea for a new  
product we would like to discuss its  
production with you.



## Plantar Von Frey™ Instrument

For Assessment of Animal Sensitivity to Light Touch of the Paw

The Plantar Von Frey™ is a new instrument from Ugo Basile for assessment of touch sensitivity. The rat, mouse or other small rodent moves about freely on a metal mesh surface in an enclosed area. The operator slides a touch stimulator unit under the animal, using a mirror to locate the exact point on the foot to stimulate. A button press causes a plastic monofilament to move up to touch the animal with a preset force. The filament will move up to a centimeter to make contact, then hold the application force until the operator releases the button, or the animal moves. The normal animal response, paw withdrawal reflex, is recorded when the touch is detected.

Maximum force and ramp speed are adjustable and are set on controller unit. Dual chamber acrylic enclosures over the perforated metal floor contain the animal, which is unrestrained, and may move about within the enclosure. The researcher waits until the animal is stationary, positions the filament under the paw, and operates the button to perform the test. Bilateral testing is possible. Complete with the stimulator, controller unit, stand, and 2-animal enclosure.

**57820** Plantar Von Frey™ Instrument



## Touch Test™ Sensory Evaluator

Semmes Weinstein Von Frey Aesthesiometer for Touch Assessment

This set of 20 monofilaments is based on the Semmes Weinstein monofilament set, but now **features retractable filaments** to protect the filament and allow

the evaluator to carry a few around in a pocket. The Semmes Weinstein set of monofilaments provide an approximately logarithmic scale of actual force, and a linear scale of perceived intensity. They have a long history of effective use in clinical settings, and can be used to diagnose pathologies of hyper- or hypo-aesthesia. Subsets within the set of 20 probes distinguish pathologies on different parts of the body (foot, hand, lip, cheek, etc.).

The operating principle remains the same: when the tip of a fiber of given length and diameter is pressed against the skin at right angles, the force of application increases as long as the researcher continues to advance the probe, until the fiber bends. After the fiber bends, continued advance creates more bend, but not more force of application. **This principle makes it possible for the researcher using a hand held probe to apply a reproducible force, within a wide tolerance, to the skin surface.**

Rodents exhibit a paw withdrawal reflex when the paw is unexpectedly touched. The Touch Test™ Sensory Evaluator can be used on the Plantar surfaces of the foot of a rat or mouse, and the animal will indicate sensation by pulling back its paw. Replacement filaments available. Call for pricing.

**58011** Touch Test™ Sensory Evaluator Kit



## Smedley Hand Dynamometer

### Grip Strength Measurement

The Smedley Hand Dynamometer is a hand held instrument for measuring grip strength, fatigue rate, and recovery rate. The dominant hand should be 10% stronger than the nondominant hand. This comparison is frequently used in neuropsychological test batteries to assess function of the nervous system.

The handle is adjustable to fit the grip length of the hand. The Smedley Hand Dynamometer measures grip strength up to 100 kilograms in 500 gram graduations.

Two dial hands move up together, but one "freezes" at the maximum grip achieved, while the other follows the grip up or down to show the current squeeze strength.

Available with a bridge transducer for use with a chart recorder or data collection system, such as the PowerLab®.



**19117** Smedley Hand Dynamometer  
**56380** Smedley Hand Dynamometer  
w/Transducer

## JVP Domes

### Replaces Two Point Calipers for Cutaneous Spatial Resolution Measurement

The JVP Domes are the most sensitive method of measuring human tactile spatial resolution.

#### Validation studies have demonstrated that:

- The JVP Domes detect deficits in sensitivity that are reported by subjects, but cannot be detected or quantified with Von Frey hairs or two point calipers.
- Measurements are reproducible and, unlike two point caliper measurements, are not subject to learning effects.
- The neuroanatomical basis for performance in this test is the density of innervation of mechanoreceptive afferents/touch fibers. (**Van Boven and Johnson, The Limit of Tactile Spatial Resolution in Humans, Neurology 44:2361-2366, 1994**). Many references available.

The set consists of 8 acrylic probes. Each probe has a columnar handle and a dome shaped head. The head has an alternating ridge/slot pattern of different width for each probe. The ridged head is pressed against the skin, and the patient/subject must report the alignment of the ridges, longitudinal or transverse. Number of answers correct with each probe is fed into an equation that interpolates and yields a sensitivity number.



The purpose of the dome shape is to reach into concave surfaces like the skin below the lower lip. The standard probes are suitable for testing fingers and facial areas for sensitivity. The back or forearm might be too insensitive for even the widest spacing in this set. An extensive bibliography is available, including normative data on various body surfaces. Set comes with an illustrated manual with several citations.

**18020** JVP Domes  
**18021** Blank Dome, Optional



# IN VITRO FERTILIZATION



## Sonic Sword

### Fast Reliable Zona Penetration With Minimal Cell Damage

Penetrating an ovum to the zona pellucida with a glass pipette, with no more damage than the size of the

injection pipette mandates, is one of the technical challenges of the ICSI technique. **The Sonic Sword makes this task easy, and enables consistent, reliable results.** In addition, it allows quick unblocking of clogged pipette tips. The Sonic Sword, with a 6 mm mounting shaft, mounts readily on most common micromanipulators.

Piezoelectric technology allows abrupt acceleration to a high velocity for precisely reproducible distances, which may be set from 1 to 60 microns. **These fast, stabbing actions move through the cell membrane with less stretching and tearing than is possible with slower movements, and stop abruptly at the correct depth, without overshoot.** Penetration in this manner is less traumatic to the oocyte, and results in higher yields of successful implantations.

The Sonic Sword comes with the electronic controller, footswitch, manual, and pipette holder.

**51230** Sonic Sword

## Migration-Sedimentation Chamber

### For ICSI Sperm Preparation

This sperm sedimentation chamber separates live motile sperm from those aggregated due to anti-sperm antibodies or low vitality. No centrifugation is necessary, so there is no sperm

tail damage. What remains is a very high percentage of vigorously A-motile spermatozoa, and almost no immotile spermatozoa. The end result is an increased fertilization rate.

The chamber may be sterilized by gamma irradiation. No gradient media are required, simply use culture medium. Raw semen, with the minimum of preparation, can be used.

**51220** Sperm Separation Chamber

## ICSI Pipettes

### Injection, Holding, Assisted Hatching, & Denuding Pipettes

This selection of pipettes is designed for use in ICSI or other cell injection operations. Various bend angles and tip configurations are available. Tip openings of injection pipettes are beveled, and may be purchased with or without a spike for sharper, smoother cell entry. Holding pipettes are flame-polished to a smooth rounded end, with a much larger OD than ID opening.

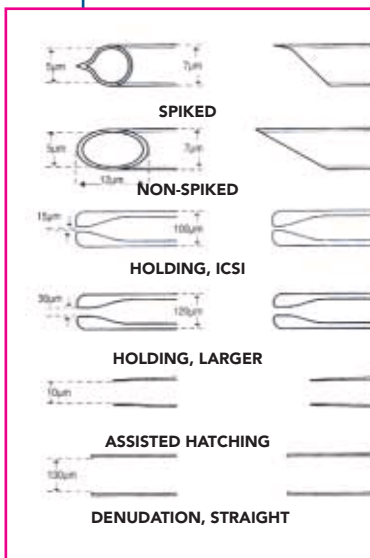

Bending angles of 0°, 20°, 25°, 30°, and 35° are available. Angles of 30° and 35° are most frequently used.

Pipettes are manufactured in a clean room facility, and shipped individually sealed in easily opened sterile vials in packs of 5.

Bend Angle	0°	20°	25°	30°	35°
<b>Spiked</b>					
Injection	<b>50900</b>	<b>50902</b>	<b>50904</b>	<b>50906</b>	<b>50908</b>
<b>Non-Spiked</b>					
Injection	<b>50910</b>	<b>50912</b>	<b>50914</b>	<b>50916</b>	<b>50918</b>
Holding, ICSI	<b>50920</b>	<b>50922</b>	<b>50924</b>	<b>50926</b>	<b>50928</b>
Holding, Larger	<b>50930</b>	<b>50932</b>	<b>50934</b>	<b>50936</b>	<b>50938</b>
Assisted Hatching	<b>50940</b>	<b>50942</b>	<b>50944</b>	<b>50946</b>	<b>50948</b>
Denudation, Straight	<b>50950</b>	<b>N/A</b>	<b>N/A</b>	<b>N/A</b>	<b>N/A</b>

# Manual Microsyringe Pump

*For Injecting or  
Withdrawing Precise  
Fluid Volumes*

The Manual Microsyringe Pump, manufactured by Stoelting, is a convenient instrument when using visual feedback to determine the amount to be infused or withdrawn. It also provides an economical means for any application requiring injecting/withdrawing a calibrated volume under manual control.

### Applications

The Microsyringe Pump has numerous applications: ICSI microtitration, chromatography, microinjections, etc. For example, for microinjection, precise placement in brain tissue is obtained by mounting glass pipettes on the electrode carrier of a stereotaxic instrument. The output is conducted from the syringe to the tissue through PE tubing.

### Two Models Available

The 51218 model has a rotating barrel micrometer that can only be used to push the plunger of the microsyringe.

The 51222 features a special micrometer with a non-rotating barrel and a clamp to bind the syringe plunger to the micrometer. This arrangement can be used for injections and fluid withdrawal (push-pull) with syringes 25 µl and larger.

### Delivers Precise Fluid Volumes

The Starrett® micrometer used is graduated in 0.010 mm increments. One complete rotation advances the plunger of the syringe 0.5 mm. The syringe is a Hamilton® 700

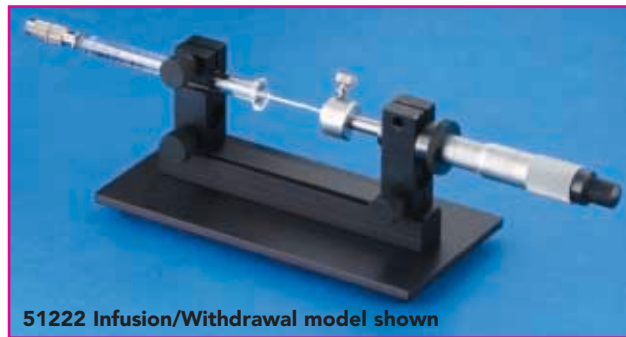

51222 Infusion/Withdrawal model shown

Series, 100 microliter syringe, with standard male Luer connector, accurate to 0.01% of graduated volume.

### Accommodates Most Syringes

Stoelting's Microsyringe Pumps accommodate a wide range of syringes and microsyringes such as those below, to enable a wide range of volumes to be delivered.

### Digital Micrometer Option

The 51218 for infusion only, is available with a digital micrometer for convenient digital readings in microns. Also may be read in inch units. Connection to a computer for automated recording of dose injected is possible.

### Accessories Included

The Microsyringe Pumps come with 1 Hamilton® 100 Microliter syringe, 1 male and 1 female Luer Lock-to-tubing adaptor and 10 ft. of Intramedic® PE polyethylene 60 tubing, .030" I.D., x .048" O.D.

### Specifications

Microdrive Range:	25.4 mm (1 inch)
Linear Resolution:	10µ
Tubing Included:	PE 60, ID 0.030", OD 0.048"
Volume Resolution:	
(10 µl syringe)	0.0018 µl/div
(25 µl syringe)	0.00416 µl/div
(50 µl syringe)	0.012 µl/div
(100 µl syringe)	0.0167 µl/div
(250 µl syringe)	0.0417 µl/div
(500 µl syringe)	0.0833 µl/div

- 51222** Infusion/Withdrawal Pump
- 51218** Infusion Pump
- 51218D** Infusion Pump w/Digital Micrometer

See page 88  
and our  
website for a  
complete  
selection of  
available  
syringes.

## Hamilton 700® Syringes

- 51112** 10.0 µl Syringe, Luer Tip
- 51113** 25.0 µl Syringe, Luer Tip
- 51114** 50.0 µl Syringe, Luer Tip
- 51115** 100.0 µl Syringe, Luer Tip
- 51116** 250.0 µl Syringe, Luer Tip
- 51117** 500.0 µl Syringe, Luer Tip
- 51162** Tubing, PE 60, 10 Ft.
- 51224** Adaptor, Syringe to Needle (Male)
- 51225** Adaptor, Syringe to Tubing (Female)





## Microprocessor Controlled Syringe Pumps

*More Features than  
Competitive Pumps*

The Microprocessor Syringe Pumps in this catalog have more features than comparable pumps from other manufacturers.

### FEATURES

All pumps in this series, even the economical single syringe model, include the following convenient features:

- Library of Syringe Models and Sizes
- Volume Dispense Mode
- LCD Displays Infusion Rate or Infused Volume (Continuously Updated)
- Optical Encoded Back Pressure Protection

### Library of Syringes

To calculate the plunger-advance speed needed to achieve a specified infusion rate, the pump needs the diameter of the plunger of the syringe(s). **Each pump has a library of plunger diameters of common syringes stored in permanent memory.** You may scroll the library to select the make and then the size. Manual entry of the plunger diameter of uncommon syringes is, of course, possible. **To begin an infusion, you need only select the syringe from the library, enter a rate, and press Start.**

### Volume Dispense Mode

The volume dispense mode automatically stops the pump after a preset volume is infused (or withdrawn). This prevents risk of over-injection, damage to syringes or wear on the pump by forcing a stall. Pumps from other manufacturers require you to enter a rate and time. You must calculate the time setting from the desired rate and volume.

All pumps are protected with an optical encoder; pump motors will not burn out when syringe is plugged or jammed.

### Display of progress

When the volume dispense mode is used, the pump's LCD will display the amount infused. This will be retained in the event of power failure. If the volume dispense mode is not used, the LCD will display the rate at which the plunger is moving.

### Series 100 Pumps

The Series 100 Syringe Pumps are an economical line of pumps for small loads. They are smaller than the Series 200 pumps, but can push up to 20 lbs. of force on the plunger. There are no ports for external control, that is, they can only be operated from the keyboard. The step rate from one step/30 sec. up to 400 half steps per sec., allows a wide range of smooth travel speeds.

The Series 100 pumps include the 53100 Infusion Pump (holds 1 syringe), the 53101 Microliter Infusion Pump (holds two microliter syringes, and operates at 1/6 the speed range of the 53100, which makes it suitable for slow infusion and for micro-dialysis applications), and the 53120 Push Pull Pump (holds 2 syringes, and pushes one plunger at the same rate the other plunger is pulled).

### Series 200 Pumps

All pumps in this series have more powerful motors (a total of 40 lbs of force before stall) and smaller micro steps (0.165 $\mu$ ). That, together with a higher pulse rate maximum (1600/sec) enables a wider range of smoother travel rates.

### External Control

Series 200 pumps come standard with a serial port for direct computer instructions and/or data logging, and a

# SYRINGE PUMPS

separate jack for TTL or foot switch control (triggering or gating). One TTL pin is a running indicator which may be used to signal other devices.

The Series 200 syringe pumps hold either 2 or up to 10 syringes, which must be identical, except on the 53250. It accommodates up to 4 syringes, each of which is held independently, and may be of different sizes.

## Infusion/Withdrawal

Models for infusion only or for infusion and/or withdrawal (all plungers in the same direction at any one time) are available. **Infusion/withdrawal pumps can be set to infuse only, withdraw only, infuse then withdraw, withdraw then infuse, or continuously cycle back and forth.**

## Push Pull Models

The Push Pull Pumps simultaneously push the plunger on one of a pair of syringes, while pulling the plunger on the other. They can be used to withdraw and infuse at precisely the same rate, so there is no net volume change. All pumps in the 200 Series have only one drive screw, so there can be only one speed of plunger movement.

## Programmable Models

For each pump in the 200 Series, there are two versions, standard (one instruction step) and programmable (up to eight instruction steps). For the programmable models, each step may include:

- Time duration from 1 sec up to 12 hrs.
- Travel direction, infuse or withdraw
- Flow rate at the beginning of the step
- Flow rate at the end of the step (continuous smooth ramp between)
- Pause, wait for external trigger or gate
- Set status of TTL output pins
- Loop back to previous step
- Number of times to repeat loop

The program may be stored in memory for future use.

## Microdialysis Model

The 53101 Microdialysis Pump holds two syringes, in microliter sizes only, and operates at very low speeds with virtually pulseless flow.

## Syringe Pump Selection Guide

Standard Model Programmable Model	53100 N/A	53101 N/A	53200 53202	53220 53222	53250 53252	53120 N/A	53260 53262	53210 53212	53230 53232
SPECIFICATIONS	Infusion Only Pumps				Push Pull		Infusion or Withdrawal		
Max. # of Syringes	1	2	2	10‡	4*	1 pair †	2 pair †	2	10‡
Syringe Size Range	10µl-60ml	10µl-10ml	10µl-140ml	10µl-140ml ‡	10µl-10ml	10µl-10ml	10µl-60ml	10µl-60ml	10µl-10ml ‡
Min. Flow Rate . (µl/hr), 10µl syr	0.21	0.035	0.001	0.001	0.001	0.035	0.001	0.001	0.001
Max. Flow Rate (ml/min)	2.08	21	21	147	21	21	21	21	21
Max. Force (lbs)	20	40	40	40	40	20	40	40	40
Min. Speed (µ/min)	2.11	0.132	0.66	0.33	0.66	0.132	0.66	0.66	0.66
Max. Speed (mm/sec)	0.212	0.003	0.012	2.12	0.012	0.003	0.012	0.012	0.012
Weight (lbs./kgs.)	4.5/2.0	5.0/2.3	9.0/4.0	9.5/4.3	9.0/4.0	5.0/2.3	9.0/4.0	9.5/4.0	9.5/4.3

\*May be different sizes

† Each pair consists of two same sized syringes, one facing in each direction, one infusing and one withdrawing

‡ Depending on load, can operate four 100ml - 140ml syringes, six 20ml - 60ml syringes, or ten 10µl - 10ml syringes

## Optional Syringe Pump Accessories

- 53203** Serial Port Cable
- 53205** Foot Switch
- 51225** Adaptor, Syringe to Tubing (female)
- 51224** Adaptor, Syringe to Needle (male)
- 51162** Tubing, PE 60 1.22 mm OD, 0.76 mm ID, 10 ft

See our website for a complete array of syringes available from Stoelting.



## SYRINGE PUMPS

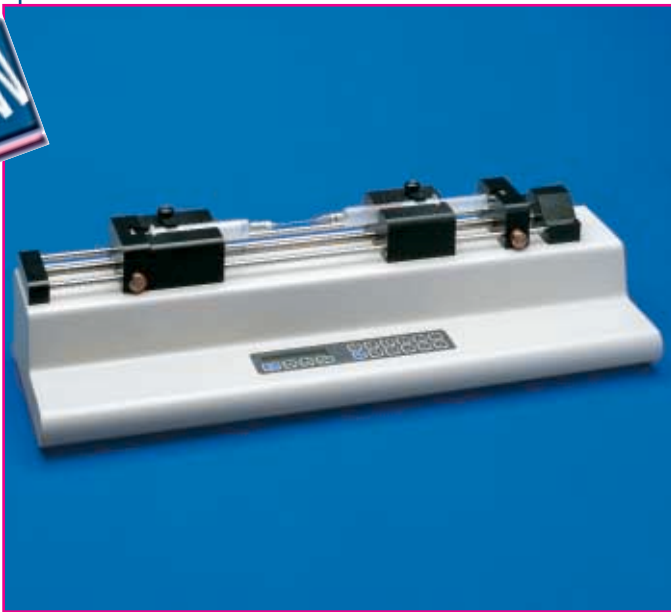

# Hand Saver™ Microemulsion Instrument

### Emulsify Adjuvant for Antigen Injections Without The Manual Labor

The Hand Saver™ forces adjuvant/antigen mixture, or other viscous fluids, back and forth through a micro-emulsifying needle. This pump will thoroughly emulsify very thick suspensions to the viscosity that is essential prior to injection, automatically. The Hand Saver™ Microemulsion Instrument does the job without the fatiguing requirement to manually push plungers back and forth.

**Let Hand Saver™ do the work, while you do the planning. Includes two 10cc syringes and needle.**

### Specifications

Syringe Size:..... 10 cc glass, Popper #5127  
 Movement Range:..... 2 inches  
 Volume Range:..... 1-9 cc  
 Force:..... up to 40 lbs.

**53330** Hand Saver™ Microemulsion Pump

# Nano Injector, Stepper Motorized

### For Precisely Controlled Infusion of Nanoliter Volumes

See pages  
100-107 for our  
selection of  
micromanipulators



**53310** Mounted on  
Micromanipulator

The syringe drive controller contains a library of common syringes and plunger diameters, so the user may simply scroll the list to select the syringe being used.

Injection directly through a needle on the syringe avoids the compliance issues that arise when injections are forced through a plastic tubing.

The stepper motor drive pushes the plunger of a Hamilton® 700 Series syringe, any size from 10 to 100µl, at a pre-set flow rate, until a pre-set volume has been injected. Volumes as small as 1 nanoliter may be set, and flow rates from 0.01µl/min to 200 µl/min, depending on syringe size selected. Slow infusions are more likely to stay in place, and not be forced back along the needle track, since the neural tissue has more time to adjust to the incoming fluid.

Plunger drive allows fast forward, fast reverse operation. Comes with mounting rod in place.

### Specifications

Syringes Accepted:.. Hamilton 700 Series, 10 µl to 100 µl  
 Syringes Not Accepted:..... Hamilton Gas Tight Series (plunger too tight)  
 Minimum Flow Rate:..... 0.01 µl/min  
 Maximum Flow Rate:..... 200 µl/min  
 Minimum Volume Settable:..... 0.001 µl  
 Connecting Cable Length:..... 180 cm

**53310** Nano-Injector



# SYRINGE PUMPS

## Monoject Plastic Syringes

Plastic disposable syringes, without needles, are supplied in sterile, single syringe packages, except the 140cc syringe, which is non-sterile. All come with male



Luer Lock connector, except the 60 cc, with a male Luer only.

- 53405** 3cc/Box of 100
- 53407** 6cc/Box of 100
- 53410** 12cc/Box of 80
- 53413** 20cc/Box of 100
- 53415** 35cc/Box of 100
- 53417** 60cc/Box of 30
- 53419** 140cc/Box of 20

## Perfectum® Glass Syringes

Precision fit glass syringes and plungers with matching numbers for high pressure syringe pump applications. Manufactured from high quality Borosilicate Resistance Glass.



All Perfectum® syringes have Luer lock connectors made of chrome-plated brass. They are fitted to heavy glass bases

to assure greater strength than glass luer tips. All luer needles lock into Needle Lock Tips with an easy twist.

- 53420** 1 cc./Box of 12
- 53421** 2 cc./Box of 12
- 53422** 3 cc./Box of 12
- 53423** 5 cc./Box of 12
- 53424** 10 cc./Box of 12
- 53425** 20 cc./Box of 12
- 53426** 30 cc./Box of 12
- 53427** 50 cc./Box of 6
- 53428** 100 cc./Box of 4

## Hamilton Microsyringes

### 1700 Series Gas Tight Syringes

This type of syringe, for use with liquids or gases, features a precision-machined TEFLON® PTFE plunger tip. The barrels are glass with



Teflon Luer Lock tips, except the 10 µL and 25 µL sizes, which have Luer tips. Gas tight syringes can not be used with the 53310 Nano-Injector.

- 53431** Syringe, 10 Microliter
- 53432** Syringe, 25 Microliter
- 53433** Syringe, 50 Microliter
- 53434** Syringe, 100 Microliter
- 53435** Syringe, 250 Microliter
- 53436** Syringe, 500 Microliter

See 'Pumps and Fluid Flow Equipment' on our website for more Microsyringes

## Stainless Steel Syringes

**Guaranteed leak-free up to 750 psi (5,175 kPa)**

These stainless steel syringes are for high pressure applications or for dispensing aggressive chemicals. Both the barrel and the plunger are of stainless steel, with Viton "O" rings. All wettable parts are #316 stainless steel or Viton.

End fittings are standard Luer lock connectors (except the 8 ml size, which has a 1/16" Swagelok® tip) for convenient mating to a wide selection of commercially available fittings.

- 53441** Stainless Steel Syringe, 5 ml
- 53442** Stainless Steel Syringe, 8 ml
- 53443** Stainless Steel Syringe, 20 ml
- 53445** Stainless Steel Syringe, 50 ml
- 53447** Stainless Steel Syringe, 100 ml
- 53449** Stainless Steel Syringe, 200 ml



Save up to 70% on Surgical Instruments  
See page 30

## Swivels

### Electrical and/or Fluid Swivels With 1" Spring Tethers Suitable for Rats and Similar Size Rodents



53503 shown

#### Electrical or 1 Fluid Channel Swivels

One channel fluid swivels are permanently sealed. Internal volume of the 20 gauge swivel is 20 µl. Internal volume of the 22 gauge swivel is 15 µl.

- 53503** Swivel, 3 Electrical Ch.
- 53505** Swivel, 5 Electrical Ch.
- 53509** Swivel, 10 Electrical Ch.
- 53510** Swivel, 1 Fluid Ch., 20 ga.
- 53512** Swivel, 1 Fluid Ch., 22 ga.



53520 shown

#### Electrical and 2 Fluid Channel Swivels

Two fluid channels on the side, one with 20 gauge and one 22 gauge hypodermic tubing ports. All seals are replaceable with 53528 Tool Kit and the 53529 Replacement Seals Kit.

- 53520** Swivel, 2 Fluid
- 53522** Swivel, 2 Fluid, 5 Elec.
- 53524** Swivel, 2 Fluid, 10 Elec.
- 53528** Tool Kit for Seals
- 53529** Replacement Seals



53532 shown

#### Electrical and 3 Fluid Channel Swivels

These combination swivels have 3 fluid channels, all on the side, with one 20 gauge and two 22 gauge hypodermic tubing ports. All seals are replaceable with 53528 Tool Kit and the 53539 Replacement Seals Kit.

- 53530** Swivel, 3 Fluid
- 53532** Swivel, 3 Fluid, 3 Elec.
- 53534** Swivel, 3 Fluid, 5 Elec.
- 53528** Tool Kit for Seals
- 53539** Replacement Seals

## Single and Dual Channel Fluid Swivels

### For Mice, Rats, & Rabbits



Swivels allow a fluid connection to a freely moving animal without the risk that the animal will twist and tangle the connection.

**These swivels are the finest available. They are precision machined and polished from stainless steel to assure the optimum in long life, smooth operation, and reliable seal performance. Fluids passing through the swivel touch only stainless steel hypodermic tubing and Teflon®. Special self-adjusting seals, at the heart of every Instech swivel, actually improve with use to prevent leaks which can ruin an experiment.**

They are designed to be attached to harnesses, or to surgically implanted buttons. And for optimal performance they should be firmly fixed outside the animal's cage with a swivel/cage mount (facing page).

#### Single Channel Swivels

Fully autoclavable and they may be reused hundreds of

times. Each swivel includes a universal swivel-to-tether clamp that connects to all tethers, buttons, and harnesses.

- **53620**—Larger ID swivel for blood pressure measurement or IV feeding with rats, standard infusion with rabbits.
- **53622**—Standard single channel swivel for infusion of rats.
- **53625**—Ultra-low-torque swivel for infusion of mice and microdialysis.

#### Dual Channel Swivels

The second fluid channel on these swivels enables you to infuse and withdraw simultaneously, to infuse on one channel while monitoring on the other, or to infuse on two lines independently.

- **53630**—Larger ID dual channel swivel for blood pressure measurement or IV feeding with rats, standard infusion with rabbits.
- **53632**—Standard swivel for dual channel infusion of rats.
- **53638**—This remarkable new swivel has quartz lining on both the center and side channels, and has very low frictional torque making it the first dual channel swivel that can be used with mice.

- 53620** Swivel, 1 Fluid, 20 Gauge
- 53622** Swivel, 1 Fluid, 22 Gauge
- 53625** Swivel, 1 Fluid, 25 Gauge
- 53630** Swivel, 2 Fluid, 20 Gauge
- 53632** Swivel, 2 Fluid, 22 Gauge
- 53638** Swivel, 2 Fluid, 22 Gauge Quartz



**53552 Rat Jacket**

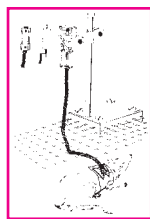

**53557 swivel support stand**

## Rodent Tethering Jacket, and Stand

Tethering jackets wrap around the rat's body, with the forelegs

through sleeve holes. Button on the end of the tether must be sewn to the jacket with nylon or stainless steel wire thread.

- 53551** Jacket, 100-150 grams
- 53552** Jacket, 150-250 grams
- 53553** Jacket, 250-350 grams
- 53554** Jacket, 350-500 grams
- 53556** Button, pkg 6, w/o tether
- 53557** Swivel Support Stand

## Buttons, Tethers and Cage Mounts

Swivel tethers are attached to jackets, or to surgically implanted buttons. Buttons may be polysulfone, for temporary use, or Dacron® Mesh for long term secure use. Tethers may be disconnected from the button when not in use. Fixed or counterbalanced mounts hold the swivel centered over the cage for rodents.



**53559**

shown in the picture. Swivel shown is not included; choose any fluid swivel from this page.

- 53575** Button, Polysulfone for 1 channel Swivels, w/Tether
- 53576** Button, Polysulfone for 2 channel Swivels, w/Tether
- 53578** Button, Dacron Mesh for 1 channel Swivel, w/Tether
- 53579** Button, Dacron Mesh for 2 channel Swivel, w/Tether
- 53559** Large Animal Strain Relief Tether
- 53582** Fixed Mount, up to 8"
- 53584** Counterbalance 6"
- 53586** Counterbalance 3.5"
- 53588** Lid Mount for Nalgene® Metabolism Cage

Fluid swivels designed for rodents may be used with larger animals when using the strain relief tether attachment

## Clear Animal Enclosures

These durable polycarbonate enclosures have been designed to house tethered rodents during short-term microdialysis and infusion experiments. Since the tank is round, tethers will not tangle as they sometimes can in shoebox-type cages. Also,



animals are less likely to dislodge sensitive probes since there are no sharp corners. Handles at the top make it easy to move around the lab.

The enclosures are most frequently used with the Fixed or Counterbalanced Mounts. Feeders, water bottles and tops are available for both the rat and the mouse enclosures.

- 53590** Mouse testing Tank
- 53595** Rat Testing Tank
- 53599** Rat Tank w/Removable Bottom



## Fixed or Counterbalanced Mounts For mounting fluid swivels to animal cages

The Swivel Mount firmly fixes a swivel above standard Nalgene Metabolism cages. Vertical and horizontal mounting bars with hardware, and new cage top with pre-drilled mounting holes are included.

## Counterbalanced Lever Arms

Instech's counter-balanced lever arms move vertically and horizontally with the animal to prevent slack in the tether. While most other lever arms use a mass as the counterbalance, ours use an adjustable spring which makes them lighter and more responsive.

The mounting plate can be adjusted for mounting to the side or top of many types of cages, including our 53595 Rat Testing Tank. If you are using a shoebox-type cage, the 53584 Counterbalanced arm can prevent the tether from tangling. The 53584 is a 6" arm that is typically used with rats. The 53586 is a 3-1/2" arm that is practically a requirement for any infusion or microdialysis study involving mice.

- 53582** Fixed Mount, Up to 8"
- 53584** Counterbalanced Arm 6"
- 53586** Counterbalanced Arm 3.5"
- 53588** Swivel Mount for Nalgene Met.



## Synaptosome Superfusion System

### Apparatus for Raiteri's Method of Synaptosome Transmitter Release Measurement

Neurotransmitter release is a major and regulated step of neurotransmission. **Superfused isolated synaptosomes are the preparation of choice to study the detailed events of neurotransmitter regulation and release.** Pharmacological agents, disease processes and internal chemistry all affect release of neurotransmitters from the synaptosomes.

This is a commercial, semi-automated version of the apparatus developed by Raiteri (M. Raiteri, F. Angelini, G. Levi: "A simple apparatus for studying the release of neurotransmitters from synaptosomes" European Journal of Pharmacology. 25: 411-414, 1974) and utilized in over 200 publications.

**In this instrument, the synaptosomes, or brain slices, are supported in very thin layers on microporous filters.** An upper reservoir serves each of 12 superfusion chambers. Pre-warmed, oxygenated media is delivered from the reservoirs to the superfusion chambers by a



multichannel peristaltic pump. The superfusate samples are directly collected into scintillation vials.

**Heated water circulation and multichannel peristaltic pump are required but not included.**

- 54800** Superfusion System (w/o Pump)
- 53712** Peristaltic Pump, 12 Channel

## Variable Flow Peristaltic Pumps

### Analog and Digital Speed Control Models

Variable Flow Peristaltic Pumps are ideal for animal perfusion studies, reagent and chemical transfer, or chromatography. Simon® model peristaltic pumps have an analog dial speed control while Vera® model pumps have precision digital control. These pumps are extremely versatile and possess many unique features:

- Variable flow; from 1 ml/min to 3450 ml/min
- Flow setting retained in pump memory
- Flow direction reversible, for purging lines
- Remote start/stop operation via optional foot switch
- Chemically-resistant pump head (molded of glass-filled Noryl®) has three stainless steel rollers and plexiglass safety cover

Each pump comes complete with one pump head and 4 ft of Silicone tubing (size 17, 1/4" I.D.). See page 94 for complete selection of tubing links and bulk tubing.

### Specifications

Speed Range.....	24-720 RPM
Motor Size.....	1/10 HP
Flow Rate.....	1-3450 ml/min (dependent on tubing size)
Dimensions.....	10 1/4 x 9 x 5 in.
Weight.....	12 lbs.



- 53600** Simon® Peristaltic Pump
- 53601** Simon® Peristaltic Pump w/ Remote
- 53603** Vera® Peristaltic Pump
- 53604** Vera® Peristaltic Pump w/ Remote
- 53654** Silicone Tubing Link (size 17, 1/4" I.D.)
- 53641** Optional Foot Switch (remote start/stop)

See "Pumps & Fluid Flow Equipment" on our website for a complete selection of peristaltic pumps.



# Quixell™ Cell Transfer System

*For the automated transfer of selected cells*

Quixell™, manufactured by Stoelting, selects single cells, or clusters, with rapid, smooth, precise control. In no time at all, a single cell can be targeted, then “click-click” on the keypad...the cell is collected into the pipette, and automatically transferred to the individual wells of a microtiter plate. Quixell's™ unique aspiration and expulsion system allows transfer of 1-5 cells at a time, into a single well.

Find, identify and select viable cells—and transfer any number of cells direct to a microtiter plate. Quixell's™ program then returns the pipette to the same position on the source plate.

## Revolutionary pipette system

Precise, microprocessor-controlled pipette positioning makes Quixell™ the ultimate cell selection and transfer system. Pipette tips are available for working with cells as small as 5 microns, up to cell clusters as large as 500 microns.

## Hybridomas

Quixell™ allows establishment of many cell lines from single-cell progenitors in less than an hour. This allows for establishing multiple cell lines rapidly, for eventual screening and selection of the hybridoma line with the optimal phenotype.

## Phenotype Selection

Quixell™ can be used to segregate cell types, based on phenotypic differences. Select and transfer the cells of interest -one at a time- or in multiples.

## Selection of Labeled Cells

Feed labeled or tagged proteins to a mixed cell culture. Quixell™ can then separate macrophages and other phagocytic cell types from all other cells.

For Cloning and Sub-Cloning Cell Lines



Compatible with inverted microscopes already in most labs.



## Selection of Fluorescent-Labeled Cells

Quixell™ also can be used to select living, transformed cells containing reporter genes such as GFP (Green Fluorescent Protein) or luciferase. Focus, switch to fluorescence activation, then locate and select desired cells.

## Sterile Operation

Quixell™ is supplied as a fully remote controlled system which permits operation under a sterile hood. The Quixell™ System includes a motorized microscope stage (holds two microtiter plates, petri dishes or slides); a stage controller; keypad/joystick, and a pipette positioning arm. Pipettes are sold separately, in packages of 12. **Microscope and video monitor are not included.** Quixell™ is compatible with the inverted microscopes already in most labs.

<b>55260</b>	Quixell™ Cell Transfer System
<b>55261</b>	Domestic Installation Available
<b>55262</b>	Demonstration Video
<b>55282</b>	Pipettes, 20 Micron
<b>55283</b>	Pipettes, 30 Micron
<b>55285</b>	Pipettes, 50 Micron
<b>55288</b>	Pipettes, 80 Micron
<b>55289</b>	Pipettes, 150 Micron

See page 97 for our Touch Screen Micropipette Puller

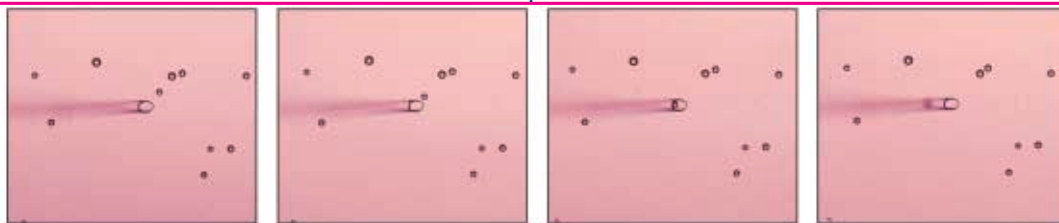

Selected cell being drawn into Quixell's™ glass micropipette. All other cells remain in place.

## Tubing Specifications

Tubing is offered in bulk rolls (most economical), or in tubing "links". Tubing links are pre-cut lengths of tubing that are specifically sized to fit in the pump head and include connector fittings. Tubing links are easier to use, extremely accurate, and won't "pull through" during operation. Tubing links are highly recommended for use in situations when narrow tubing, sizes 13 - 16 (1/32" – 1/8" I.D.), is needed. Tubing links are sold in packs of 5.

**Choose tubing from the chart below according to these selection criteria:**

- 1) Tubing inner diameter (determines flow range)
- 2) Tubing wall thickness (specific pump head design)
- 3) Chemical compatibility/tubing composition

**Silicone** Thermal set rubber Siloxane polymers and amorphous silica. Excellent compression strength. Soft material. Translucent, clear to light amber.

**Tygon®** Thermoplastic. PVC-based material with plasticizer. Firm (stiff) material. Transparent, clear.

**Pharmed®** Thermoplastic elastomer. Polypropylene-based material with USP mineral oil. Excellent tensile strength. Firm (stiff) material. Opaque, beige.

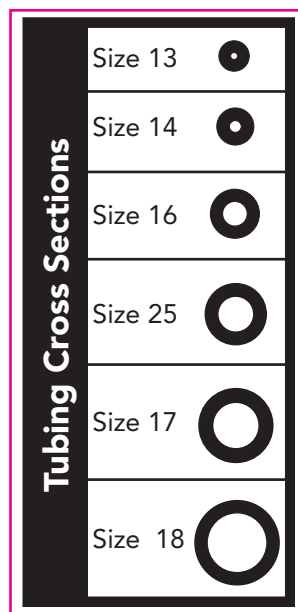

### Tubing Links (Packs of 5)

Tubing Size	Size 13	Size 14	Size 16	Size 25	Size 17	Size 18
Inner Diameter (I.D.)	1/32"	1/16"	1/8"	3/16"	1/4"	5/16"
Silicone tubing links	<b>53650</b>	<b>53651</b>	<b>53652</b>	<b>53653</b>	<b>53654</b>	*
Tygon® tubing links	<b>53655</b>	<b>53656</b>	<b>53657</b>	<b>53658</b>	<b>53659</b>	*
Pharmed® tubing links	<b>53660</b>	<b>53661</b>	<b>53662</b>	<b>53663</b>	<b>53664</b>	*

\*Tubing links not available for size 18

### Bulk Tubing

Tubing Size	Size 13	Size 14	Size 16	Size 25	Size 17	Size 18
Inside Diameter (I.D.)	1/32"	1/16"	1/8"	3/16"	1/4"	5/16"
Silicone 25 ft/pkg	<b>53670</b>	<b>53671</b>	<b>53672</b>	<b>53673</b>	<b>53674</b>	<b>53675</b>
Tygon® 50 ft/pkg	<b>53680</b>	<b>53681</b>	<b>53682</b>	<b>53683</b>	<b>53684</b>	<b>53685</b>
Pharmed® 25 ft/pkg	<b>53690</b>	<b>53691</b>	<b>53692</b>	<b>53693</b>	<b>53694</b>	<b>53695</b>

## Accessories

Foot switches operate remote control of peristaltic pumps Simon® & Vera®. Dispensing Tips for dispensing pump (Kate®) allow for better precision, less splashing at dispensing point. Sinkers keep inlet tubing submerged in source reservoir, ensuring uninterrupted pumping and no air bubbles.

- 53640** Dispensing Wand w/ DB9 Connector (replacement)
- 53641** Foot Switch (start/stop operation on remote control models)
- 53642** Autoclavable Glass Dispensing Tip w/ Luer Lock (for 3/16" & 1/4" I.D. tubing)
- 53643** Autoclavable Polypropylene Dispensing Tip w/ Luer Lock (for 1/16" & 1/8" I.D. tubing)
- 53677** Teflon Sinker, set of 2 (1 small & 1 large)
- 53678** Teflon Sinker, Small (for 1/16" & 1/8" I.D. tubing)
- 53679** Teflon Sinker, Large (for 3/16" & 1/4" I.D. tubing)
- 53644** Connector, luer-lok, for 1/32" & 1/16" I.D. tubing). Pkg. 10
- 53645** Connector, luer-lok, for 1/16" & 3/32" I.D. tubing). Pkg. 10
- 53646** Connector, luer-lok, for 3/32" & 1/8" I.D. tubing). Pkg. 10
- 53647** Connector, luer-lok, for 1/8" & 5/32" I.D. tubing). Pkg. 10
- 53648** Connector, luer-lok, for 5/32" & 3/16" I.D. tubing). Pkg. 10
- 53649** Connector, hose barb, for 3/16" & 1/4" I.D. tubing). Pkg. 12

## PE Tubing

IntraMedic™ PE tubing is the lab standard in bioinert polyethylene tubing. Use for attaching to syringe hubs for infusion, for catheterizing vessels, for tracheotomy, and for other general laboratory applications requiring small, strong, and durable tubing.

Catalog No.	Size (ID/OD, in mm)	Length
51150	PE10 (0.28 / 0.61)	10 ft
51151	PE10 (0.28 / 0.61)	100 ft
51154	PE20 (0.38 / 1.09)	10 ft
51155	PE20 (0.38 / 1.09)	100 ft
51158	PE50 (0.58 / 0.965)	10 ft
51159	PE50 (0.58 / 0.965)	100 ft
51162	PE60 (0.76 / 1.22)	10 ft
51163	PE60 (0.76 / 1.22)	100 ft

Catalog No.	Size (ID/OD, in mm)	Length
51166	PE90 (0.86 / 1.27)	10 ft
51167	PE90 (0.86 / 1.27)	100 ft
51170	PE100 (0.86 / 1.52)	10 ft
51171	PE100 (0.86 / 1.52)	100 ft
51174	PE160 (1.14 / 1.57)	10 ft
51175	PE160 (1.14 / 1.57)	100 ft
51178	PE190 (1.19 / 1.70)	10 ft
51179	PE190 (1.19 / 1.70)	100 ft

## Micropipette Glass

### Omega Dot™ and Smooth Bore

The reproducibility of pipette pullers and microforges begin with consistent glass quality. These clean, uniform borosilicate glass tubes will produce excellent results with any pipette puller or microforge.

The table presents a wide variety of sizes and wall thicknesses of glass tubes. Any of these are available with

or without an internal glass fiber, the Omega Dot™. The internal glass fiber greatly enhances the capillary action involved in filling pipettes, making quick filling possible.

Thin wall tubes pull to small tip diameters with fast final tapers, for small tips with high impedance.

Single barrel glass comes in packages of 225. **Multi-barrel pipette glass is available upon request. Please call for availability.**

OUTER DIAMETER	INNER DIAMETER					
	Thick Wall 0.50 mm I.D.		Regular Wall 0.58 mm I.D.		Thin Wall 0.75 mm I.D.	
	Omega Dot Number	Plain Number	Omega Dot Number	Plain Number	Omega Dot Number	Plain Number
<b>1 mm</b>	<b>50610</b>	<b>50611</b>	<b>50612</b>	<b>50613</b>	<b>50614</b>	<b>50615</b>
	Thick Wall 0.60 mm I.D.		Regular Wall 0.68 mm I.D.		Thin Wall 0.90 mm I.D.	
	Omega Dot Number	Plain Number	Omega Dot Number	Plain Number	Omega Dot Number	Plain Number
<b>1.2 mm</b>	<b>50710</b>	<b>50711</b>	<b>50712</b>	<b>50713</b>	<b>50714</b>	<b>50715</b>
	Thick Wall 0.75 mm I.D.		Regular Wall 0.84 mm I.D.		Thin Wall 1.12 mm I.D.	
	Omega Dot Number	Plain Number	Omega Dot Number	Plain Number	Omega Dot Number	Plain Number
<b>1 .5 mm</b>	<b>50810</b>	<b>50811</b>	<b>50812</b>	<b>50813</b>	<b>50814</b>	<b>50815</b>
	Thick Wall 1.00 mm I.D.		Regular Wall 1.12 mm I.D.		Thin Wall 1.50 mm I.D.	
	Omega Dot Number	Plain Number	Omega Dot Number	Plain Number	Omega Dot Number	Plain Number
<b>2.0 mm</b>	<b>50800</b>	<b>50801</b>	<b>50802</b>	<b>50803</b>	<b>50804</b>	<b>50805</b>



## Platinum, Silver and Nichrome Wire

### With or Without Teflon® Insulation

Stoelting offers a selection of wires for use with glass pipette microelectrodes. Silver wire is pure silver. Platinum wire is 90% platinum, 10% iridium, which adds

to rigidity. Nichrome wire is a nickel chromium alloy for thick heating coils. Teflon® coating is available as indicated.

<b>50880</b>	Silver Wire, 0.13 mm (.005"), Bare, 10'
<b>50881</b>	Silver Wire, 0.13 mm (.005"), Teflon, 10'
<b>50882</b>	Silver Wire, 0.25 mm (.010"), Bare, 10'
<b>50883</b>	Silver Wire, 0.25 mm (.010"), Teflon, 10'
<b>50884</b>	Platinum Wire, 0.13 mm (0.005"), Teflon, 10'
<b>50025</b>	Nichrome wire, 1.3 mm (.051"), Bare, 5'





## APP-H Micropipette Puller

*Silent Operation,  
Program Storage,  
Affordably Priced*

### Simple Programming

The bright LCD display prompts the researcher through program menus. Specifying pipette characteristics is easy. Only 4 arrow keys and an enter key are required to scroll through and interact with the instrument. Each program may have up to 10 stages. **Up to 100 named programs**

### FEATURES

- Widest range of any puller—tip openings from 1 to more than 250 $\mu$ .
- Shank length controllable over a wide range, 3 mm to 25 mm.
- Concentric pipette tips
- Silent operation
- Feedback controlled coil temperature
- Instant Recall™ keys for one touch loading of stored programs

for alternate pipette shapes may be stored in non-volatile memory. Several sample programs are installed at the factory, and may be used, edited, or replaced to suit the researcher's needs.

### Instant Recall™

Any pipette specification program in the unit's memory may be assigned to any one of the five programmable function keys. **Turn on the instrument, touch that function key, and the unit is ready to pull the specified pipette.** There is no need to scroll to locate the programs you use most frequently. This time-saving feature is unique to Stoelting's APP-H Micropipette Puller.

### Feedback Controlled Heater Coil

The temperature of the heater coil on the APP-H is feedback controlled. As the coil impedance changes with age, or a new coil is inserted, it is not necessary to modify your programs. The APP-H senses the changes in coil temperature, and adjusts the current flow. **The instrument adjusts, so you don't have to. Competing pullers require that you adjust your programs as the coil ages, or is replaced.** Further, the constant current method used on other pullers requires lowering the temperature to make the final break. This is usually an air puff, which must be consistent in temperature and humidity. Stoelting's APP-H Micropipette Puller utilizes temperature feedback to initiate the next stage of pull at precisely the correct temperature. No air blast or air dehumidifier is necessary.

### Silent Operation

Stoelting's APP-H Micropipette Puller employs a lightweight moving-coil actuator to create the pull force. The low inertia allows abrupt acceleration to break the glass, but the coil stops without the traditional loud bang. If people are thinking, reading, or studying in or near your lab, they will be grateful for the silent operation of your APP-H Micropipette Puller.

### Concentric Pipettes

A centering fixture supplied with each APP-H puller allows you to form your own coils, and reshape and center the coil for the pipette size you will be using. This assures even heat distribution around the pipette, and concentric pipette tips.

### Specifications

Glass diameter: ..... 0.5 mm to 2 mm  
Range: ..... 1.0 to >250 $\mu$   
Stages/program: ..... up to 10  
Program storage: ..... up to 100

<b>52500</b>	APP-H Micropipette Puller
<b>52502</b>	Platinum Heater Coil
<b>52503</b>	Extra Heater Block
<b>51553</b>	Platinum Wire, 0.016", 10 ft

See page 95 for a variety of glass for micropipettes. We have a wide selection from which to choose, with the most popular sizes and thickness.

## MICROPIPETTE APPARATUS

# Micropipette Puller

### For Pulling Single and Multiple Barrel Pipettes

The Micropipette puller has been completely redesigned, with all function controls via Touch Screen control pad. Pull Strength and Heat Intensity are now digitally controlled. New safety features, such as override circuit and smooth surface design, protect the operator from fire hazard and facilitate cleanup / removal of glass chips. Up to 100 settings (Pull Strength and Heat Intensity) may be preserved in the puller's resident memory. The Operation Manual is stored in resident memory, as is a Help Menu, so you will never have to search for the instructions. See our website for complete specifications.

- 51210** Vertical Micropipette Puller
- 50028** Heating Coil 3/8" O.D., .051" diameter wire
- 50025** Nichrome Wire .051" diameter, 5ft



New touch screen control pad.



### Pipette Vial Holder

Holds 3 pipette vials, up to 1.25" in diameter. Doubles as a convenient instrument holder. Magnetic backing.

- 51216** Pipette Vial Holder



### Micropipette Storage Container

Store and transport micropipettes. Secures micropipettes and electrodes to prevent damage to tips.

- 51214** Micropipette Storage Container, Pkg of 3

Free vial holder and 3 storage containers with all pullers.

# Turbo™ Microbeveler

### Faster Cutting, Smoother Finish, Fast Throughput

When beveling pipettes, getting it done fast and smoothly without breaking the pipette is the primary goal. **A new type of cutting wheel in this instrument makes beveling a 7 micron ICSI pipette up to 45 times faster than with conventional bevelers.** And it is permanent, not an abrasive that needs to be mixed or added. It is mounted on a very stable, extremely low vibration motor.

### Visual Process Control

The beveler is built onto a high-resolution compound microscope with 20x objectives and 20x eyepiece for 400x magnification, with a measuring reticule. The grinding process can be controlled by the researcher under visual guidance to very precise and consistent sizes. Illumination, irrigation, pipette angle, pipette position, and pipette rotation are all provided and built



into this compact unit, arranged for speed and efficiency. Supplied with power supply and control box.

- 55175** Turbo™ Microbeveler



## DeFonbrune-Style Microforge

*Fabricate Glass Microtools For the Most Demanding Applications*

The classic DeFonbrune-style microforge is still the most versatile microforge for fabricating glass microtools. This instrument can be used to produce simple microprobes, hooks, and needles, but can also produce loops, calibrated micropipettes, microscalpels, microcups, and micromanometers (for intracellular pressure measurements), tools that cannot be produced with a micropipette puller alone, or with other microforges.



Close-up of Heater and Microtool Holder

### Microtool Holder

The microtool holder is mounted on a metal disk that can be rotated 360° about the optical center to allow the microtool to enter the field of view from any direction. The disk can be locked with a pin with the

microtool in either the vertical or horizontal position. These functions allow for very precise control of glass forging operations, and make this the most versatile microforge available.

Both the heater filament and the microtool are easily removed or inserted via spring loaded clamps. A variety of heating filaments may be installed; Platinum/Iridium, Chromel, or other, with thickness appropriate to the glass tip being forged.

### With a DeFonbrune Microforge, you may adjust:

- Heater current flow
- Cooling air flow
- Horizontal and vertical position of the microtool
- Illumination level
- Rotation of the microtool holder about the optical center
- Heater position, in the horizontal or vertical plane
- The heater may be pivoted parallel to the optical axis

These functions allow for very precise control of glass forging operations, and make this the most versatile microforge available.

The Microforge consists of: a mechanical micromanipulator with six separate, maneuverable spatial controls to manipulate microtool position and orientation; an electrical system for control of current flow to the heating filaments; an air-flow cooling system; Platinum/Iridium heater; instruction manual; set of starter tools; a microscope mount; and illumination system.

**51500** Microforge, w/o Optics

### MICROSCOPES, STEREO

Includes required bonder arm focusing mount

**51571** Nikon SMZ-645

**51573** Olympus SZ-6045

### CONSUMABLES AND ACCESSORIES, INCLUDED

**51502** Heating Filament Holder

**51503** Weight Set w/forceps, case

**51504** Hammering Rod

**51505** Bulb, Frosted, Illuminator

**51506** Tool Holder Clamp

**51507** Fuse, (ACG 5, 1/4 x 1-1/4")

**51508** Filament Wire, 31 ga. Plat/Ir, 4"

**51509** Filament Wire, 30 ga. Plat/Ir, 4"

**51511** Accessory Kit, Weights w/microtools

**51512** Filament Holder Assembly

## SCIENTISTS/INVENTORS

We welcome your ideas. If you have developed an instrument, or have an idea for a new product we would like to discuss its production with you.

# Stoelting Microforges

*New Bonder-Arm Base  
Readily Accepts Most  
Makes/Models of  
Stereomicroscopes*

Microforges enable the fabrication of hooks, curves, blades, bulbs, flame polished tips (as used in the patch clamp technique) and other microtools that cannot be produced by pulling alone.

### Stable, Precise

Stoelting microforges feature massive, stable construction for fabrication of microtools in even the submicron range.

**The microforge is operated by moving the heating element in the optical plane. Coarse microdrives in 3 dimensions and a fine drive in the lateral direction are provided. The movements are visually guided through the microscope, and the heater is controlled with a footswitch.**

The illuminator may be moved in the vertical and horizontal directions to allow centering on the microscope.

### Choice of Microscopes

Select from the following continuous zoom stereomicroscopes with bonder-arm focusing mounts, or use your own.

**Nikon** SMZ-645 Stereozoom with 20x widefield eyepieces, fitted with a 25 mm reticle, and a 2x front end lens to give a zoom range of 16-200x. With bonder-arm focusing mount.

**Olympus** SZ-6045 Stereozoom, with 20x eyepieces, fitted with a metric scale reticle, and a 2x front end lens to give a zoom range of 20-252x. With bonder-arm focusing mount.

The **standard tool holder**, included, is a 1/4" Jacobs Chuck. Available options include an adaptor clamp (51558) for holding Leitz® microinstrument sleeves (51534, set of 3) and the rotating chuck.



51550 with 51571 optics

### Rotating Chuck

**The rotating chuck (see picture)** has a variable speed motor to rotate the glass about its long axis as it is being worked. This is necessary for work with theta glass and other applications.

**Microforges supplied without microscope.**



See pages  
96-97 for  
Vertical and  
Horizontal  
Pipette  
Pullers

- 51550** Microforge, w/o Optics
- 51560** Microforge, Rotating w/o Optics

#### STEREOMICROSCOPES

- 51571** Nikon SMZ-645
- 51573** Olympus SZ-6045

#### ACCESSORIES

- 51552** Platinum Heater
- 51553** Plat. Wire, .016", 10'
- 51554** Replacement Heater Holder
- 51556** Illuminator Bulb
- 51558** Adaptor Clamp
- 51534** Microinstrument Sleeves, Leitz®



# DOVETAIL SLIDE MICROMANIPULATORS

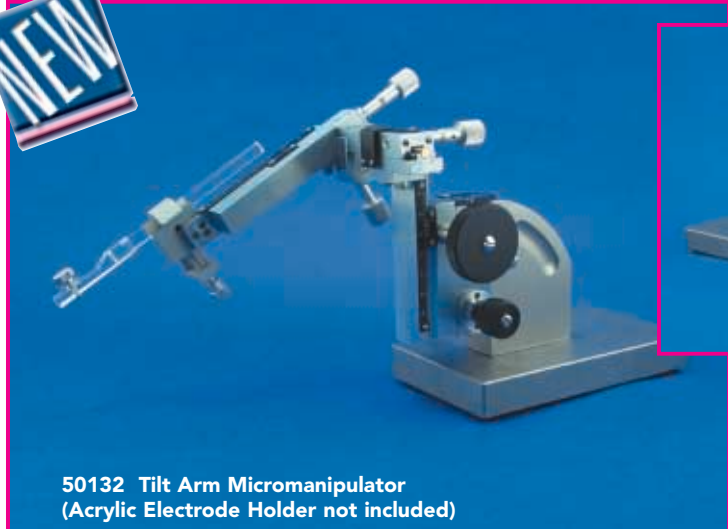

**50132 Tilt Arm Micromanipulator**  
(Acrylic Electrode Holder not included)



**50130 Fixed Arm Micromanipulator**  
(Acrylic Electrode Holder not included)

## Stoelting's Exclusive Dovetail Slide Micro-manipulators

*Holds greater weight without slippage or drift than any ball bearing slide micromanipulator*

Stoelting is proud to introduce its new line of precision dovetail slide micromanipulators. These micro-manipulators were based upon the classic dovetail micromanipulators no longer available from Prior Co. Stoelting took the best features of these popular dovetail slide micromanipulators, and engineered several major design improvements.

### Strong Construction

Micromanipulators are manufactured from brass. The precision dovetail slide construction used on these micromanipulators is significantly more durable, and holds greater weight without slippage or drift, than any ball bearing slide micromanipulator available.

### Fixed or Tilt Arm Models

Micromanipulators are available with a fixed or a tiltable X axis arm. The fixed arm version has the X axis locked at

precisely 90 degrees. The tilt arm version can be rotated to any desired angle and securely locked.

### Coarse Axis Drives

The dovetail slides are driven by rack and pinion mechanisms for rapid positioning to a resolution of 0.1 mm on the coarse vertical (Z) and lateral (Y) drives. The probe

direction (X) drive is also graduated in 0.1 mm increments, but has an anti-backlash worm drive for more precise control of movement.

### Z Axis has a Fine Drive

The fine drive, graduated in 0.01 mm increments, is located on the base of the Z axis. This is especially useful where the specimen is in a Petri dish or microtiter tray. The probe holder allows mounting of any rod or pipette, even up to 1/2" diameter.

These micromanipulators can be mounted directly on several bases via the most secure dovetail slide mount. Alternatively, we have designed ring mounts, which allows mounting onto any 1/2" rod.

### Innovative Probe Clamp

Stoelting's most stable probe clamp is now an integral part of every dovetail micromanipulator. This adjustable probe clamp allows firm hold of the widest range of probe and electrode diameters, providing absolutely steadfast grip of any probe, rod or electrode holder from 1/4" to 1/2". Together with these new features, Stoelting's dovetail slide micromanipulators provide better performance than their predecessors.

**Bases not included, see next page.**

### Specifications

Axis.....	Range .....	Resolution .....
X.....	.65 mm .....	0.1 mm .....
Y.....	.28 mm .....	0.1 mm .....
Z.....	.65 mm .....	0.1 mm .....
Z fine .....	2.2 mm .....	0.01 mm .....
Weight .....	1.25 kg. w/o base	

- 50130** Fixed Axis Micromanipulator, R.H.
- 50131** Fixed Axis Micromanipulator, L.H.
- 50132** Tilt Arm Micromanipulator, R.H.
- 50133** Tilt Arm Micromanipulator, L.H.
- 50140** Micromanipulator base
- 50145** Mounting ring bracket
- 28093** Electrode/Probe Holder
- 50134** Prior Style Mounting Block



## Manipulator Base

### For Stoelting Dovetail Slide Micromanipulators

The rectangular base is the most popular micromanipulator base for dovetail slide manipulators. This newly designed manipulator base has the capability to move the vertical dovetail lock. The dovetail slide micromanipulator can be mounted along the wider side, in its standard configuration. For a smaller footprint, the vertical dovetail mount block can be repositioned so that the manipulator is centered on the side. **When mounted on the side, the mass of the manipulator base provides counterbalancing ballast and even greater stability.**

**50140** Rectangular Manipulator Base



## Mounting Ring Bracket

### For Stoelting Dovetail Slide



### Micromanipulators

This mounting ring bracket attaches quickly to Stoelting Dovetail Slide micromanipulators, clamping tightly to any 1/2" steel rod. Use the Mounting Ring Bracket in conjunction with either Ultracompact micromanipulator stands (55109 or 55110), with the standard Flexbar™ or heavy duty Flexbar™ bases, the microscope stage attachment, or any of the three post mount stands on page 104.

**50145** Mounting Ring Bracket

## Manual Hydraulic Microdrive

Hydraulic microdrives, by virtue of remote control, transmit no hand vibration. They are capable of making smooth, accurate axial probe, or electrode, movements in increments as small as 1.0 $\mu$ . **The drum dial is graduated to read directly in microns.**

Coarse control for rapid positioning is also provided. Rotation of the calibrated drum wheel on the control unit imparts probe movement through a sealed hydraulic system to the remote, separately mounted slave cylinder on which the probe or electrode is mounted.

The slave cylinder provides axial probe movement with a range of 15 mm. It is connected to the master cylinder by a flexible tube three feet long.

**51421** Microdrive, Standard

**51426** Adaptor to Lab Standard™ Stereotaxic

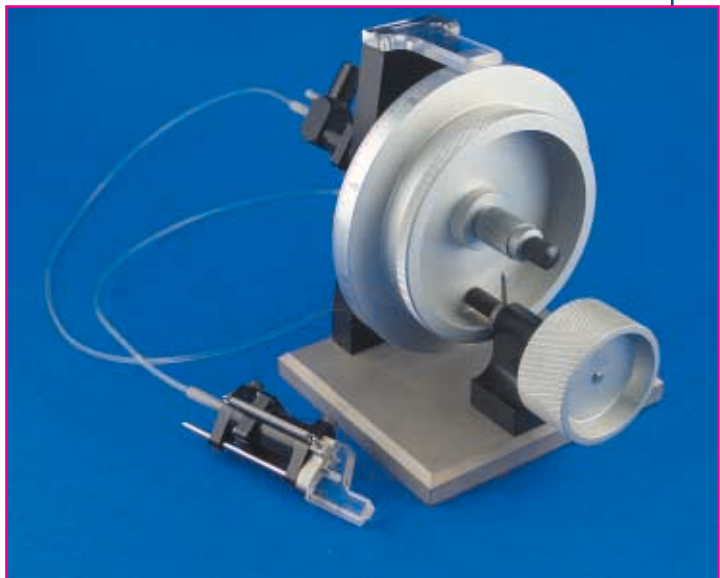

# DC3-K Motorized Micro- manipulator

*Remote Controlled  
Micromanipulator  
for Patch  
Clamping and  
Fine Movement  
Applications*

The DC3-K motorized micromanipulator provides remote controlled, vibration-free fine travel, plus coarse drives, in all 3 dimensions. The remote control provides stability suitable for patch clamping.

### Micromanipulator

Convenient features include a swivel up hinge on the probe motor to allow it to be tilted up to 90° and locked securely in place. The probe holder may be swung out to the side to change pipettes and returned to precisely the original position.

Stoelting provides these micromanipulators with shielded cables, an acrylic probe holder, and joystick or push button controller.

### Three Dimensional Joystick Controller

The joystick controller allows control of the micromanipulator movements in the X, Y, and Z axes simultaneously. Speed of movement is regulated by the degree of displacement of the joystick from the center "null" position. The vertical (Z) drive is controlled by rotating the knob on the joystick.

Manipulator movements are lag-free. The micrometers are graduated in 10 micron increments, movements of 2 or 3 microns can be controlled under visual guidance through a microscope.

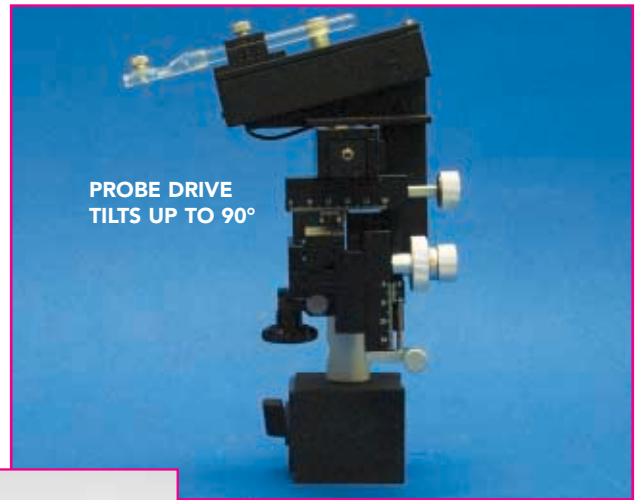

### Push Button Controller

Single "steps" from .50 microns to 10 microns can be executed with the push button controller.

The push button controller has 6 buttons, one each for forward and reverse in each of the 3 axes. A touch of the button triggers a step of the preset size. Holding the button down for over a second produces continuous smooth movement at a preset speed. A unique feature of this controller is the electronic backlash compensation. When the direction of movement is reversed, a compensatory pulse of preset size corrects

for lost motion.

A handheld remote control accessory unit (55315) is available to operate one axis at a time from a distant location.

### Specifications

Range, Coarse:.....	X 37 mm
	Y 20 mm
	Z 20 mm
Range, Fine:.....	all axes 10 mm
Resolution, Fine:.....	0.5 μ
Maximum Velocity/step:.....	0.2 mm/sec.
Size:.....	154 mm x 112 mm x 130 mm

#### WITH PUSH-BUTTON CONTROLLER

- 55335 Micromanipulator, RH
- 55340 Micromanipulator, LH

#### WITH JOYSTICK CONTROLLER

- 55335-3 Micromanipulator, RH
- 55340-3 Micromanipulator, LH
- 55315 Remote Handpiece



## MM 33 Micromanipulators

### Single and Dual Probe-Holder Models

These high precision micromanipulators are widely used in laboratories throughout the world. They feature silky smooth roller bearing slides, and a highly space efficient design.

The micromanipulator is equipped with three coarse movements and an additional fine drive in the axis of the tool holder.

Suitable for use at microscope magnifications up to approximately 250x.

### Ergonomic Design

A unique feature of this series of manipulators is the positioning of all control knobs in a single plane. This permits several manipulators to be positioned side by side with unimpeded access to the knobs, and facilitates one-handed, eyes-on-the-microscope operation.

Stainless steel cross roller bearing raceways with rack and pinion drive provide zero backlash, long life and fast positioning in the X, Y and Z axes. These drives have a resolution of 0.1 mm over a travel of 20 mm in the lateral and vertical planes, and 37 mm in the probe direction. Additional fine positioning is provided by a precision drive micrometer with a resolution of 0.01 mm and a travel of 10 mm in the probe direction.

### Tilt Base and Post Mount Models

Available on a tilt base or on a clamp for post mounting on a 1/2" rod. The tilt base can tilt up to 75° from the vertical. An optional, weighted base (55120), available from Stoelting, can be attached to the tilt base for extra stability.

A selection of post mount bases and "Flexbar" positioning devices is available from Stoelting. Our 55110 Ultra Compact Manipulator Stand is especially suitable to take advantage of the compactness of this series of manipulators (see pages 94 & 95).

## SCIENTISTS / INVENTORS

We welcome your ideas. If you have an idea for a new instrument or improving an existing one, we would like to talk to you.

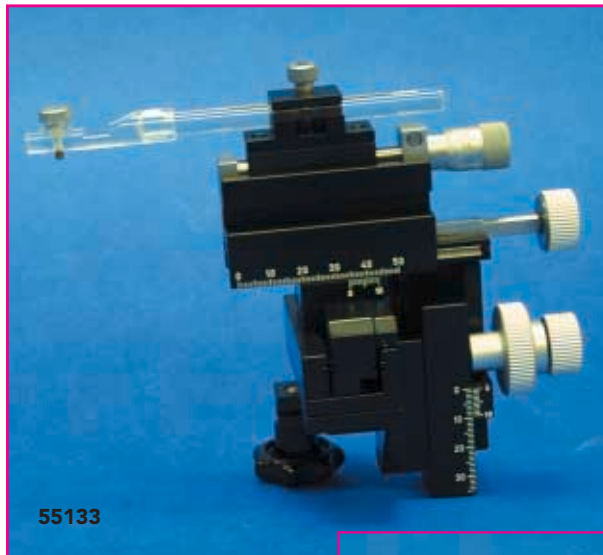

55133

### Dual Probe Holder Model

For even greater space efficiency, these manipulators are also available with 2 probe holders.

The added probe holder has a set of 4 additional fine controls allowing independent movements of 8 mm in the lateral and probe directions, and rotation of 10° in the plane of the two probes or perpendicular to it.



55135

#### POST MOUNT

- 55133 MM 33, Right Hand
- 55233 MM 33, Left Hand
- 55129 MM 33, w/2 Probe Holders, Right Hand
- 55229 MM 33, w/2 Probe Holders, Left Hand
- 55119 Tilt Base to Connect Post Mount to Tilt Base
- 55116 Connecting Rod 1/2" x 4"

#### TILT BASE

- 55135 MM 33, Right Hand
- 55235 MM 33, Left Hand
- 55130 MM 33, Right Hand with 2 Probe Holders
- 55230 MM 33, Left Hand with 2 Probe Holders
- 55118 Clamp to Convert Tilt Base to Post Mount
- 55120 Optional Weighted Attachment for Tilt Base

Microscope stage attachments, electrodes and probe holders, and other accessories are on page 105.



## Post Mount, 1/2" Stands & Accessories



### Magnetic Stand

Overall height approximately 14", base approximately 2" high. On-Off switch for magnet. Post, 1/2" diameter, comes with V-block slider to hold any rod (not included) from 0 -1/2" diameter.

- 55115** Magnetic Stand
- 55116** Connecting Rod  
1/2" x 4"
- 55114** Magnetic Steel  
Plate



### Magnetic Stand, Ball Jointed/Heavy Duty

Magnetic Stand with ball jointed rod. Extra powerful On-Off magnetic base. Overall height approximately 13", base approximately 2" high. Slider holds any rod (not included) from 0" to 1/2".

- 55169** Magnetic Stand
- 55116** Connecting Rod  
1/2" x 4"



### Articulated Arm

This stand offers flexible positioning without sacrificing stability. It is easy to manage as it is moved into position and can be locked with one knob.

Top can be positioned anywhere within an eleven inch radius. On/off magnetic base.

- 55155** Articulated Arm



**55110** Patented swivel mechanism adapts to even the most difficult positioning requirements.

## Ultra Compact Micromanipulator Stand

The ultimate in positioning efficiency. The compact design allows positioning of many micromanipulators within a very small area.

Patented swivel mechanism may be assembled in many ways. Swivels easily to allow convenient access to any position for standard 1/2 inch (12.5 mm) post mount micromanipulators. The center of gravity is always stable within the boundaries of the base.

Available on a magnetic base or on a flat, weighted non-magnetic base. The optional Magnetic Steel Plate can be used for additional stability and as a counter-weight. Simply use it in conjunction with the Ultra Compact Stand with magnetic base (55110).

- 55110** Ultra-Compact Stand on Magnetic Base
- 55109** Ultra-Compact Stand on Weighted Base
- 55114** Magnetic Steel Plate (4-1/2" x 7", 5 lbs.)

## Universal Microscope Stage Attachment

Mount one or more post-mount micromanipulators directly to the stage of your microscope. The Universal Microscope Stage Attachment will attach to any stage or table surface up to 1.75 in thick.

The position of the micromanipulator mounting post with respect to stage can be adjusted over a wide range. The mounting rod is 1/2" x 4" and fits most standard post-mount micromanipulator.

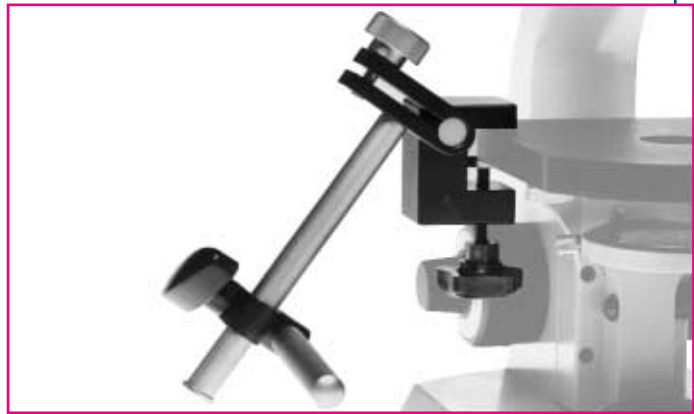

**55117** Universal Microscope Stage Attachment

## Microelectrode Holders

Plexiglass microelectrode holders may be used with all micromanipulators sold by Stoelting.

The microelectrode holders can hold one or two glass micropipettes or microelectrodes.

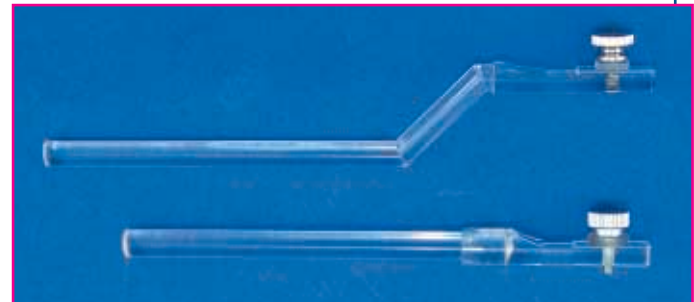

**28093** Electrode Holder, Straight

**28094** Electrode Holder, Offset

## Flexbars

Flexbars can be flexed into any position and securely locked. The **Tom Thumb** flexbar on magnetic base is perfect for working in confined areas. Entire assembly is adjustable from 8" to 10". Clamps rods up to 1/4" diameter.

The **Standard** flexbar is available on a magnetic base, or a "C" clamp base (base has 1 3/8" opening). Stability is better than .0001". The Standard flexbar is 10" long, supports 3 lbs., and clamps rods up to 1/2" diameter.

Heavy Duty flexbars are 13" long and support and position up to 4 lbs. Available on flange for screw mounting, on powerful magnetic base and on a magnetic base with a 10" high post (has fine adjustment control for exact positioning).



Flexbars 55145, and 55138

**55145** Tom Thumb on Magnetic Base

**55146** Connecting Rod, 1/4" x 3"

**55138** Flexbar on Magnetic Base

**55139** Flexbar on "C" Clamp Base

**55140** Jumbo Flexbar on Flange

**55141** Jumbo Flexbar on Magnetic Base

**55142** Jumbo Flexbar, Post Mounted

**55116** Connecting Rod, 1/2" x 4"



## Oxford Micromanipulator

### 3D Movement with 5:1 Reduction

This instrument enables the operator to reduce the degree of hand movements in every dimension by a ratio of 5:1, while also being able to rotate the manipulator probe. The Oxford Manipulator is constructed almost entirely of stainless steel to minimize elasticity of movement and corrosion.

### Applications

Many instruments of this type are now in use in all fields of science and industry, e.g., embryology, mycology and the positioning of small components in manufacturing. When the manipulator is used for the transfer of mammalian ova in embryological research, a microsyringe pump, such as our 51222 Microsyringe pump, is required.

---

**55025** Oxford Micromanipulator



## Joystick Micromanipulator

### Variable Movement Reduction

Joystick micromanipulators provide movements that are direct reductions of the speed and direction of the hand movement. Under the microscope, the probe appears to move directly with the hand. The joystick drives the probe in the X and Y (horizontal) directions. The ratio of movement reduction can be adjusted in the range of 16:1 to 66:1.

This instrument has coarse positioning in 3 axes, with an additional reduction knob on the Z (vertical) axis for fine movements (1 rotation = 3mm) Range X: 37mm (coarse), Y: 21mm (coarse), Z: 24mm (coarse and fine).

A stop on the Z axis may be preset to prevent the probe from being inadvertently broken by being driven down into the slide or dish. The probe holder may be tilted up to 90° as desired.

- 
- 55360** Joystick Manipulator on  
1/2" Post Mount Clamp, RH  
**55361** Joystick Manipulator on  
1/2" Post Mount Clamp, LH  
**55362** Optional Clamp for Stage Mounting

## Custom Drives

### Lightweight Dovetail Slides and Drives



#### Fine Drive

Two precision dovetail drives mounted at right angles to each other on a 90° tilting bracket. Calibrated micrometer drive screws provide precise movement control. Accepts 55492 Electrode Holder clamp. These are suitable for use at 500x magnification. Travel range is 6 mm.

- 55475** Fine Drive, X&Y, RH
- 55476** Fine Drive, X&Y, LH
- 55477** Fine Drive, X only
- 55492** Electrode Holder Clamp



#### Reduction Drive

The same drives as described in the 55460 series, except with one knob and fitted with a 5:1 reduction drive. The reduction drive makes these suitable for magnifications up to 250x. The reduction drive may be mounted on either side.

- 55481** Drive, Red., LH, 60 mm
- 55482** Drive, Red., RH, 60 mm
- 55485** Drive, Red., LH, 95 mm
- 55486** Drive, Red., RH, 95 mm

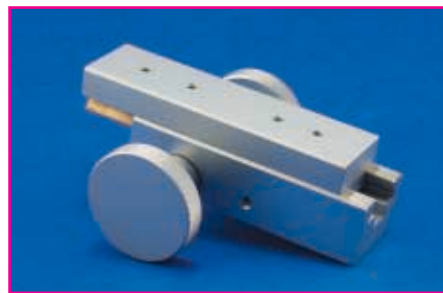

#### Rack & Pinion

Dovetail slides with rack & pinion drives can be configured with other drives on this page to make custom manipulators. Sturdy light metal construction. **Knobs on both sides (BH) or either side (LH or RH).**

##### 60 mm Drives

- 55460** Drive, R&P, BH
- 55461** Drive, R&P, LH
- 55462** Drive, R&P, RH

##### 95 mm Drives

- 55464** Drive, R&P, BH
- 55465** Drive, R&P, LH
- 55466** Drive, R&P, RH

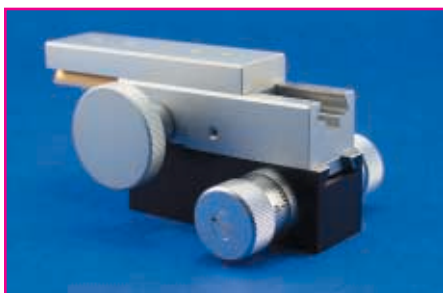

#### Coarse & Fine Drive

A combination rack & pinion coarse drive and microscope type fine drive. The coarse drive covers 65 mm of travel with 0.1mm resolution and the fine drive covers 3 mm with .004 mm calibrated resolution, making this drive useful for up to 750x.

Useful as a vertical or focus drive on custom configured micromanipulators.

- 55490** Drive, Coarse and Fine



#### XY Drive

Two thin, light, rack and pinion drives mounted at right angles to each other via a 90° tilting bracket. Suitable for light loads only. Drive knobs on top make one model suitable for left or right hand operation. Accepts 55492 Electrode Holder. Range of 75 mm in X direction, 55 mm in Y.

- 55495** Drive, R&P, X&Y



#### Dovetail Microdrive

This dovetail slide is configured with a micrometer with 25 mm travel and 0.01 mm (10 μ) resolution for fine drive operation. It is spring loaded to prevent any backlash. Suitable for use at 250x magnification. Width 25 mm, length w/o micrometer, 120 mm.

- 55498** Dovetail Microdrive





## Effective Range of 10 MM

The Piezomanipulator PM-10 features a single controller for both a DC micromanipulator and a piezoinjector (PM-20). A keystroke activates a piezo advance of preset speed and distance (0.5 to 10 microns). Then, the piezo element is contracted at a more gradual rate which is electronically coordinated with an equal and opposite advance of the DC motor drive, resulting in negligible movement of the pipette tip in the second phase.

**The net effect is a series of forward stabs produced by key presses that do not have to be followed by retractions, thus giving the functional equivalent of greatly expanded range (10 mm) to the piezo advance.** Holding the same key down produces a continuous DC motorized advance.

A second key produces DC motorized retraction, and four other keys control forward and reverse DC stepper motorized movement in the other two axes. One simple controller with 6 buttons and 3 knobs (step size on all 3 axes, piezo speed, and continuous DC motor speed) controls all operations of this device.

Two BNC jacks on the back panel accept TTL pulses to mimic presses of the forward and reverse buttons for the piezo/DC drive.

## Low Lateral Vibration

Great care was taken to minimize lateral vibration. Strict cylindrical symmetry was required, even to the mounting of the pipette in the concentric center of the forward drive. That, and specially designed vibration stabilizers, are responsible for the excellent lateral stability of this system. Lateral deviation at the pipette tip is less than  $\pm 5\%$  of the forward step size.

Different mounting mechanisms are available to fit the Piezomanipulator to different microscopes. A selection of holders for various pipette sizes is also available. The 51442 Probe Holder for patch clamping or for injecting a cell while recording has both electrical and pneumatic connection to the pipette. Order holders separately.

## Specifications

Range: ..... 10 mm X, Y, Z axis  
 Step size: ..... 0.50-10  $\mu$ m  
 Deviation from ideal axis: .....  $\pm 5\%$  of step size  
 Advance velocity: ..... 1-100 mm/sec  
 Vertical rotation range: .....  $\pm 3^\circ$  swivel

- 51447** Piezomanipulator PM-10
- 51441** Standard Probe Holder
- 51442** Patch Clamp Probe Holder

# Piezomanipulator PM-10

## *For Cell Penetration and Recording*

Efficient and reliable penetration of small cells and axons requires a sharp, punctate, stabbing movement over a very small distance. The Piezomanipulator provides this type of movement with minimal pressure damage, tearing, or overshoot through the cell.

### Punctate, Stabbing Movement

Instruments based on the piezoelectric effect have greatly increased the spectrum of penetrable cells and the yield of successfully penetrated cells. These quick stabbing, punctate movements of an attached pipette allow membrane puncture with minimal compression of the cell.

The principle drawbacks of earlier piezopenetrators were the extremely limited range (a few microns at most), and uncontrolled lateral vibration caused by the extreme acceleration.

For the automated transfer of selected cells, see Quixell on page 93.



# Piezoinjector PM-20

## For Cell Penetration and Injection

The PM-20 Piezoinjector is a very efficient tool for intracellular injection. Because of the high penetration speed of the piezostepper and precise axial advance, the injection pipette can be brought to its target position with tremendous accuracy. Lateral escape of the cell is almost eliminated; even tough membranes can be penetrated. The Piezoinjector can be used with any microsyringe, picospritzer or micro injection system.

### Utilizes Piezoelectric Effect

Instruments based on the piezoelectric effect have proven most effective, greatly increasing the spectrum of penetrable cells and the yield of successfully penetrated cells.

As voltage is applied across the piezoceramic materials, it expands with immense force, giving a high acceleration over even a very short distance (e.g., 1 micron). The result is a stabbing, punctate movement of an attached pipette. This allows membrane puncture with minimum compression of the cell.

### Withdrawal Speed Independent of Penetration Speed

The withdrawal speed of the pipette may be set independently of the penetration speed. Fast withdrawal minimizes cell damage produced by adhesion of the injected cell to the pipette tip.

### Can Be Automated

Input and Output BNC jacks for TTL level triggers are provided for use in fully automatic injection systems. With an automated configuration, the pipette only has to be positioned at the cell. Penetration, injection and withdrawal can be executed, fully automatically, with the press of a button or foot switch.

### Minimal Vibration

Because of the special construction of the piezo element, a virtually perfect axial movement (a pre-requisite for vibration free penetration at very high levels of velocities) can be achieved with the Piezoinjector. The deviation from the ideal axis, even at the greatest step size setting of 20 $\mu$ , is at most 1 $\mu$  (measured at the top of the pipette holder).



The Piezoinjector is designed to mount directly on any manipulator in this catalog. If required, an attachment for mounting the Piezoinjector to other micromanipulators can be supplied. The Piezoinjector is supplied without a manipulator.

### Specifications

Step size.....	0-20 $\mu$ adjustable
Max. velocity forward .....	1-100 mm/sec
Linear Distance .....	20 $\mu$
Max. velocity reverse .....	1-50 mm/sec
Inputs/Outputs .....	5V TTL
<i>on the rear panel there is a 6-pole socket for connection of the Eppendorf injector</i>	
Fastest step sequence .....	1 forward/reverse step/sec

<b>51640</b>	Piezoinjector
<b>51645</b>	Pipette Holder
<b>51646</b>	Adaptor to Leitz®

This injection system may be used with micromanipulators that you already have. The micromanipulator must accommodate a 1.5 cm diameter probe.

See page  
100 for  
Stoelting's  
**NEW**  
dovetail  
slide  
manipulator.

## MICROSCOPE STAGES



### DC Motorized Stages with Encoders

Stage Movements Can Be Computer Controlled

These large economical stages, manufactured by Stoelting, track and display current stage position, or move to a specific location, with a resolution and repeatability of 16 microns.

**These DC Motorized Stages can be fitted to most inverted microscopes.**

The stage has openings for two inserts adapted to specific specimen trays. Inserts are available that hold 4 slides (3" x 1") each, 2 Terasaki plates each, or one petri dish (any standard size up to 76 mm. Microtitre plates fit the openings directly and do not require an insert. The total movement range covers 280mm x 70mm. Custom inserts can be made to your specifications.

The Joystick/Keypad Controller can be used in a stand-alone mode. It includes a joystick for manual control and a 16 key keypad for directing standard movements and patterns (such as stopping at each well of a microtitre tray) and an LCD to display the current stage position coordinates.

**An external computer, connected to the serial port, can operate the stage in a completely automated mode. Additionally, the 16 keys can each be assigned any signaling function desired by a computer programmer, for interactive use.**

The system comes complete with a stage, a microprocessor control box, a remote control joystick/keyboard, and all necessary cables. Inserts (2) must be ordered separately. Include the make and model of your microscope when ordering.

- 
- 55270** Position Encoder Stage System  
*Inserts: No insert is required for microtitre trays.*
- 55290** Insert, Holds 4 3"x1" Slides
- 55291** Insert, 2 Terasaki Plates
- 55292** Insert, 35mm or 60mm



### DeFonbrune Type Pneumatic Micromanipulator

One Handed Positioning in 3 Dimensions Without Backlash or Drift

**Remote control through pneumatic connections has several advantages over other actuator methods. The movement is smooth, and free of vibration, drift, and backlash.**

The joystick controls position rather than velocity, giving a much more intuitive feel to the movements. Movements can be easily reversed for left or right hand operation, or to counter reversing optics, by switching the pneumatic tubes. Movements in X and Y are controlled by comparable movements of the joystick, vertical movements are controlled by rotations of the joystick. Degree of movement reduction is adjustable over a wide range to accommodate working at any magnification up to 400x.

Two models are available, the classic counter top model, or the compact stage mount model. Both come with a moist chamber, and a variety of microtool holders and accessories for starting any application.

- 
- 55400** DeFonbrune Micromanip., Counter Top
- 55405** DeFonbrune Micromanip., Stage Mount

## Ordering Information

Stoelting appreciates your business. To make ordering convenient, we accept telephone, FAX, email, or mail-in orders.

**Call:** (630) 860-9700;  
**FAX:** (630) 860-9775  
**Email:** [orders@stoeltingco.com](mailto:orders@stoeltingco.com)  
**Address:** Stoelting Co.  
 620 Wheat Lane  
 Wood Dale, IL 60191 USA

You can also order from our website, [www.stoeltingco.com/physio](http://www.stoeltingco.com/physio)

## Minimum Billing

Orders for less than \$50.00 US must be prepaid, and can be charged to a VISA, Master Card, or shipped C.O.D. in the US and Canada. All prices are subject to change without notice, and are FOB Wood Dale, Illinois, USA.

## Export Terms

It is easy to order directly from Stoelting. We accept:

- VISA or MasterCard, or
- Purchase Order from a recognized University, International Company, or Governmental Institution, payment within 30 days, or
- Full payment with order, or
- Bank Transfer to our bank before

- shipment, or
- Letter of Credit: all LC charges to the applicant's account, including USA banking charges (Orders over \$5,000 Only. A processing fee of \$500 will apply.)

All prices are FOB Wood Dale, Illinois, U.S.A.

All prices are subject to change without notice.

## Warranty

Stoelting warrants its products against defects in materials and workmanship, for one year from receipt date. Stoelting will, at its option, repair or replace defective items within the warranty period. Stoelting shall not in any event be liable for incidental or consequential damages resulting from the use, or misuse, of its products. Please call or email for more details, or to obtain Return Authorization number for warranty repairs.

## Repair Policy

Please notify us if equipment repair is necessary. Please call or email to discuss what service is available, and to obtain a Return Authorization number. For warranty repair, a copy of original invoice/purchase order is required. Please return items in

original packaging if possible. Please include a letter with description of equipment to be repaired/service requested, and include complete contact information (your name, address, phone, FAX, and email.)

Non-warranty repairs require purchase order number or credit card information. Please call or email to describe the repair and obtain a Return Authorization number. Please include a letter with equipment number, model, serial number if appropriate, purchase order number, and date of receipt, if known. Goods returned without prior authorization may not be accepted. We will help make arrangements for shipment and receipt with your Return Authorization number.

## Return Policy

Please call or email to obtain a Return Authorization number. Goods returned without prior consent may not be accepted. Returned items received will be subject to inspection and accepted following inspection. Any returned goods will be subject to a 15% restocking fee without prior arrangements and return authorization.

<b>A</b> ctive Avoidance Test . . . . .	72	<b>B</b> asile Computer Interface . . . . .	72
Activity, Exploratory . . . . .	75	Batteries . . . . .	49
Activity, Metabolism Cages . . . . .	70-71	Beveller, micropipette . . . . .	97
Adjuvant Emulsifying Pump . . . . .	88	Bio Amp Leads . . . . .	20
Aesthesiometers . . . . .	82	Biopotential Amplifiers . . . . .	19
Alcohol Prep Pads . . . . .	49	Bipolar Electrodes . . . . .	13
Amplifiers . . . . .	15-19	Blood pressure Amplifier . . . . .	19
Analgesia instruments . . . . .	77-79	Blood pressure cuff . . . . .	20,57
Anesthesia instruments . . . . .	50-53	Blood pressure monitors . . . . .	57-60
Anesthesia, gas, on stereotaxic . . . . .	3, 5, 53	Blood pressure transducer . . . . .	20
Anesthesia Masks . . . . .	50, 53	Bone anchor screws . . . . .	12
Animal I.D. systems . . . . .	69	Bone Cutting Forceps . . . . .	43
Antiseptic solution . . . . .	49	Books . . . . .	22-23
APP-H™ micropipette puller . . . . .	96	Bouffant Caps . . . . .	47
Articulated Arm Base . . . . .	104	Brain Cannula Holder . . . . .	6
Atlas, brain . . . . .	22-23	Brain Maps, Book . . . . .	22-23
Auto Clips . . . . .	25	Brain Matrices . . . . .	68
		Brain punches . . . . .	66
		Bridge Amplifiers . . . . .	19
		Buttons Tethers & Cage Mounts	93

<b>C</b> age, Metabolism . . . . .	70-71
Calipers, digital . . . . .	12
Cannula Holder . . . . .	6
Cat Adaptor . . . . .	7
Cautery Instruments . . . . .	24
Cell culture . . . . .	108-109
Cell encoders . . . . .	110
Cell penetrators . . . . .	108-109
Cell transfer system . . . . .	93
Ceramic blade scissors . . . . .	40
Cervical Dislocator . . . . .	67
Clamps . . . . .	36
Clippers . . . . .	26
Clipper vacuum . . . . .	26
CMS Software . . . . .	71
CO2 monitor . . . . .	56
Cones, Restraint . . . . .	67
Cordless Clippers . . . . .	26
Cordless Micro Drill . . . . .	11
Cotton Applicators . . . . .	19
Cunningham Mouse & Neonatal Adaptor . . . . .	5
Cunningham Spinal Adaptor . . . . .	5



# INDEX

**D**ata acquisition .....18-19  
 DC Motorized Stages  
   with Encoders .....110  
 Decapitators .....67  
 DeFonbrune microforge .....98  
 DeFonbrune micromanipulator ...110  
 Dental cement .....12  
 Dental, drill bits .....12  
 Diamond Disk Cutting Wheel .....12  
 Digital Calipers .....12  
 Digital Lab Standard™ .....2  
 Direct Blood Pressure Monitor ...57  
 Displacement Transducer .....20  
 Disposable Scalpels .....44, 49, 68  
 Dog Adapter .....7  
 Dovetail microdrives .....107  
 Dovetail slide  
   micromanipulators .....100  
 Dovetail slide  
   micromanipulators, base .....101  
 Drapes, Surgical .....48  
 Dremel Moto-Tool .....12  
 Drills and bits .....10-12  
 Dry Sterilizer .....27  
 Dumont Forceps .....31  
 Dynamic Plantar  
   Aesthesiometer .....82  
 Dynamometer, hand .....20,83

**E**ar bars .....6  
 Ear Punch .....69  
 ECT Device .....14  
 Electronic Stethoscope .....20  
 Electroconvulsive device .....14  
 Electrode, Disposable .....20  
 Electrode Holders .....105  
 Electrode Impedance Tester .....16  
 Electrodes, Micro & Stimulating ...13  
 Electrophysiology instruments ...16-18  
 Elevator, periosteal .....42  
 EMG Cables & Electrodes .....13, 20  
 Emulsifying pump .....88  
 Euthanasia Chamber .....52  
 EZ Wound Clips .....25

**F**ace Masks .....47  
 Feeding & Drinking Monitors ...70-71  
 Fiber-optic illuminators .....29  
 Flat Treadmill .....74  
 Flexbars .....105  
 Fluovac gas scavenger .....50  
 Force Transducer .....20  
 Forceps .....31-36, 43  
 Freezing stages for microtome ...64  
 Four Channel Amplifier .....16

**G**as anesthesia instruments .....50-51  
 Gas anesthesia, for mouse .....5  
 Gas anesthesia mask,  
   stereotaxic .....3, 5  
 Gas Metabolism Cage .....70-71  
 Gas Metabolism Monitor .....70  
 Gauze sponges .....48  
 General-purpose amplifier .....16  
 Germinator™ .....27  
 Glass micropipettes .....95  
 Glass syringes .....85  
 Gloves, Exam .....46-47  
 Gowns, Procedure .....47  
 Grip strength meter .....74  
 GSR/SCR amplifier .....19  
 Guillotine .....67  
 Guinea Pig Adaptor .....7

**H**air & dander vacuum .....26  
 Halothane/Isoflurane scavenger ...50  
 Halothane vaporizer .....52  
 Hamilton® syringes .....85, 89  
 Hand dynamometer .....20, 83  
 Hand Saver Microemulsion  
   Pump .....88  
 Hargreaves Test .....81  
 Heat pad .....27  
 Hemostatic Forceps .....35  
 Homeothermic Blanket .....27  
 Hot plate analgesia meter .....78  
 Hot plate, stirrer .....28  
 Hole board for mice .....75  
 Hydraulic microdrive .....101  
 Hypophysectomy instrument .....9

**I**CSI/IVF pipettes .....84  
 Illuminators, fiber optic .....29  
 Impedance tester, metal electrode .16  
 Implantable I.D. tags .....69  
 Incapacitance Meter .....77  
 Indicator Strips, Steam  
   & EO Gas .....48  
 Indirect blood pressure  
   sensor .....57-60  
 Induction Chamber .....52  
 Inflammation, paw .....77  
 Integraslice .....63  
 Intubation needles .....66  
 Instrument cup .....28  
 Iodine solution .....49  
 Iontophoresis current source .....21  
 IR activity monitor .....75  
 Isoflurane/Halothane scavenger ...50  
 Isoflurane vaporizer .....52  
 Isometric transducer .....20  
 Isotonic transducer .....20

**J**oystick micromanipulators .....106  
 JVP Domes .....83

**L**ab Standard™ .....2-3  
 Lab Standard™, Digital stereotaxic .2  
 Large Animal stereotaxic .....4  
 Latex gloves .....46  
 Lesion making device .....14  
 Live Cell Microscopy .....93

**M**acLab (now PowerLab) .....18-20  
 Magnetic bases/stands .....104-105  
 Manual Microsyringe Pump .....85  
 McIlwain™ Tissue Chopper .....65  
 Metabolism monitors .....70  
 Metabolism cages .....70-71  
 Micro Clamps .....36  
 Micro Clip Setting Forceps .....36  
 Micro syringe pumps .....85-88  
 Microdialysis, animal enclosure ...91  
 Microdialysis, buttons,  
   tethers and cage mounts .....91  
 Microdialysis, fluid swivels .....90  
 Microdialysis, lever arms .....91  
 Microdialysis, probe holder .....6  
 Microdialysis, syringe pump .....86  
 Micro dissecting forceps .....32-33  
 Micro Dissecting Needles .....12  
 Microdrives, Dovetail .....107  
 Microdrives, Hydraulic .....101  
 Microelectrode Holders .....105  
 Microelectrode, metal .....13  
 Microforges .....98-99  
 Microinjector .....11,88  
 Micromanipulators .....100-103,  
   .....106-109  
 Micromanipulators, DC  
   motorized .....102  
 Micromanipulator stands .101,104-105  
 Microprocessor Controlled  
   Syringe Pump .....86-87  
 Micromotor Drill .....10  
 Micropipette beveller .....97  
 Micropipette pullers .....96-97  
 Micropipette Storage  
   Container .....97  
 Microscope Stage  
   Attachment .....105  
 Microscope, stereo .....96-97  
 Microsyringes .....85  
 Microtome, Sliding .....64  
 Microtome, freezing stage for ...64  
 Microtome, Vibrating .....62-63  
 Micro Vascular Clips .....36  
 Microwave fixation system .....61  
 Midgard™ Precision  
   Current Source .....21

Migration-Sedimentation Chamber	.84
MM33 Micromanipulator	.103
Monkey Adaptor	.7
Mouse Brain Atlas	.22-23
Mouse Respirator	.54
Mouse Stereotaxic Adaptor	.7
MRI Respirator	.55
<b>N</b> ano-injector	.11,88
Needle Holders	.45
Neonatal Rat Adaptor	.5
Nerve Recording	.17
Nitrous Oxide kit	.52
NU Gauze™ sponges	.48
<b>O</b> 2/CO2 Monitor	.56
Operating Scissors	.40-41
Oscillating Microtome	.62-63
Oxford Micromanipulator	.106
Oxygen Tank Yokes	.52
<b>P</b> alkovits punch set	.66
Parafilm™	.49
Passive Avoidance Test	.72
Paw pressure analgesia instrument	.77-81
Paw sensitivity	.81-82
Paw volume meter	.76
PE tubing	.95
Perfusion pump	.92
Piezoelectric cell penetrator	.108-109
Pipette Glass	.95
Pipette pullers	.96-97
Pipettes, ICSI	.84
Pipette Vial Holder	.97
Pin Vise	.12
Pituitary instrument	.9
Pharmed® Tubing	.94
Plantar™ analgesia instrument	.81
Plantar Von Frey instrument	.82
Plastic syringes	.85
Platinum/Iridium Wire	.95
Plethysmometer	.76-77
PowerLab®	.18-20
Precision current source	.21
Pressure Transducer	.20
Probe Centering Device	.13
Probe Holders, Micromanipulators	.105
Probe Holders, Stereotaxic	.6
Pulse sensor	.20
Pulse transducer	.20
Pumps, emulsifying	.88
Pumps, peristaltic	.92
Pumps, syringe	.85-88
Punch set, tissue	.66

<b>Q</b> -tips	.49
Quick Stick™ Disposable Sensors	.20
Quixel™	.93
<b>R</b> adiometer	.78
Randall-Solitto Test	.80
Rat Adaptor	.7
Rat Brain, Atlas	.22-23
Regulators, Gas Cylinder	.52
Respiration transducer	.20
Respirators	.54-55
Restraints	.66
Restraint Cones	.67
Retractors	.37
Rodent Brain Matrices	.68
Rodent Surgery Table	.68
Rongeurs, Bone	.42
Rota-rod treadmills	.73
Rotational Behavior	.79
<b>S</b> calpel Blades	.44
Scalpels	.44
Scalpels, Disposable	.44,49,68
Scavenger, anesthetic gases	.50
Scissors	.38-41
Semmes-Weinstein Von Frey set	.82
Sharps Containers	.49
Shaver, surgical	.26
Shoe Covers	.48
Shuttle Avoidance Test	.72
Silicone Tubing	.94
Silver Wire	.95
Skinner Box	.72
Slides, Dovetail	.107
Sliding Microtome	.64
Small Bird Adaptor	.7
Smedley hand dynamometer	.20,83
Sonic Sword™ cell injector	.84
Spatial resolution measurement	.83
Sperm sedimentation chamber	.84
Spinal surgery stereotaxic	.5
Spring scissors	.38
Stage Attachment, Microscope	.105
Stands, Micromanipulator	.104
Stellar™ stereotaxic instrument	.8
Stepper motor syringe pumps	.11,88
Stereomicroscope Mounting Kit	.13
Stereotaxic, books	.22-23
Stereotaxic, drills	.10-12
Stereotaxic, gas anesthesia	.3,53
Stereotaxic, Injector	.11,88
Stereotaxic instruments	.1-4
Stereotaxic, probe holders	.6
Stereotaxic, species adaptors	.7
Stereotaxic, spinal adaptor	.9
Stereomicroscope	.96-97
Sterilizer	.27
Sterilizer, dry	.27

Sterile gloves	.47
Sterilizing pouches	.48
Stethoscope, electronic	.20
Stimulating Electrodes	.13
Stir Plate/Stirrer	.28
Superfusion apparatus	.92
Surgical Instruments	.30-45
Surgical Masks	.47
Surgical tool holder	.28
Surgical supplies	.46-49
Surgical Table	.68
Suture clips	.25
Surgical lubricant	.49
Suture	.25
Swivels	.90
Syringes	.85
Syringe pumps	.85-88

<b>T</b> ail flick analgesia instrument	.80
Tethers & Swivel Jackets	.91
Tissue chopper, McIlwain™	.65
Tissue Forceps	.34
Tissue slicers, manual	.65
Touch Test™ Sensory Evaluator	.82
Towel Clamps	.36
Transducers	.20
Treadmills	.74
Tubes & tubing	.94-95
Tweezers, Dumont	.31
Tygon® Tubing	.94

<b>V</b> annas scissors	.38
Vaporizers	.52
Ventilators, animal	.54-55
Video Surgery System	.1
Von Frey hairs set	.82

<b>W</b> IN DAS software	.72
Window Discriminator	.17
Wire, platinum & silver	.95
Wound clips	.25

<b>X</b> -Cell3+ Microelectrode Amplifier	.15
---	-----

<b>Y</b> okes for Gas Cylinders	.52
---------------------------------	-----



STOELTING CO. 620 WHEAT LANE  
WOOD DALE, ILLINOIS 60191 U.S.A.

TEL: (630) 860-9700 • FAX: (630) 860-9775  
email: physiology@stoeltingco.com  
www.stoeltingco.com/physio

**MAILROOM:** If the person named on the address label is no longer with your organization, please route this catalog to their replacement. TO REMOVE FROM MAILING LIST PLEASE SEE POSTAGE-PAID ADDRESS CORRECTION CARD INSIDE.



Pharmacology  
page 72-83



Biological Functions  
page 56-60



Data Acquisition  
page 18-21



Surgical Accessories  
page 24-28



Microforger  
page 95-99

## Digital Stereotaxic

Save Time! Improve Accuracy!

- Classic Lab Standard™ Design
  - Zeroing Function for Targeting Specific Coordinates
- see page 1 for details

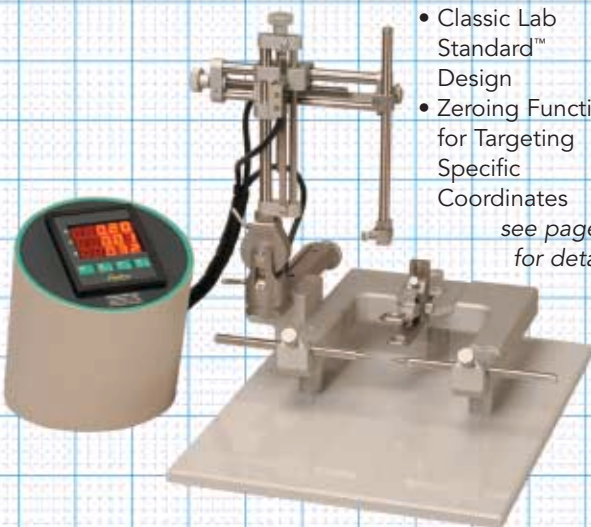

Syringe Pumps  
page 84-92



Fiberoptics  
page 29



Activity/Metabolism  
page 70-71

**ONLINE**  
Instant Quotes and Ordering!  
[www.stoeltingco.com/physio](http://www.stoeltingco.com/physio)

Phone: (630) 860-9700 Fax: (630) 860-9775  
email: physiology@stoeltingco.com